

Wireless World

ELECTRONICS, RADIO, TELEVISION

MARCH 1962

Managing Editor:

HUGH S. POCOCK, M.I.E.E.

Editor:

F. L. DEVEREUX, B.Sc.

Assistant Editor:

H. W. BARNARD

Editorial:

P. R. DARRINGTON

M. G. LAZENBY

R. H. OLIVER

W. J. A. WOODYER

Drawing Office:

H. J. COOKE

Production:

D. R. BRAY

Advertisement Manager:

G. BENTON ROWELL

- 101 Editorial Comment
- 102 Transistors in Space *By L. H. Brace*
- 106 Harmonic Analysis *By H. C. Parr*
- 110 Ionosphere Review: 1961 *By T. W. Bennington*
- 112 World of Wireless
- 114 Personalities
- 115 News from Industry
- 117 Physical Society Exhibition
- 127 Feedback, Distortion and Allied Topics *By T. Roddam*
- 130 Technical Notebook
- 131 Manufacturers' Products
- 133 Letters to the Editor
- 139 Meters and Senses *By "Cathode Ray"*
- 143 Short-wave Conditions
- 144 Fundamentals of Feedback Design—3 *By G. Edwin*
- 147 Conferences and Exhibitions
- 148 March Meetings
- 150 Unbiased *By "Free Grid"*

VOLUME 68 No. 3.

PRICE: 2s. 6d.

FIFTY-FIRST YEAR

OF PUBLICATION

Chairman: H. S. Pocock, M.I.E.E.

Managing Director: W. E. Miller, M.A., M.Brit. I.R.E.

Iliffe Electrical Publications Ltd., Dorset House, Stamford Street, London, S.E.1

Please address to Editor, Advertisement Manager, or Publisher as appropriate

© Iliffe Electrical Publications Ltd. 1962. Permission in writing from the Editor must first be obtained before letterpress or illustrations are reproduced from this journal. Brief abstracts or comments are allowed provided acknowledgment to the journal is given.

PUBLISHED MONTHLY (4th Monday of preceding month). Telephone: Waterloo 3333 (65 lines). Telegrams: "Ethaworld, London, Telex." Cables: "Ethaworld, London, S.E.1." Annual Subscriptions: Home and Overseas, £2 0s. 0d. Canada and U.S.A. \$5.50. Second-class mail privileges authorized at New York, N.Y. BRANCH OFFICES: BIRMINGHAM: King Edward House, New Street, 2. Telephone: Midland 7191. COVENTRY: 8-10, Corporation Street. Telephone: Coventry 25210. Glasgow: 62, Buchanan Street, C.1. Telephone: Central 1265-6. MANCHESTER: 260, Deansgate, 3. Telephone: Blackfriars 4412. NEW YORK OFFICE: U.S.A.: 111, Broadway, 6. Telephone: Digby 9-1197.

AW47-91

BY100 HIGH PERFORMANCE SILICON RECTIFIER

Now to be found in many sets as the mains rectifier, is the new Mullard silicon diffused junction rectifier, BY100. This rectifier has a maximum recurrent peak inverse voltage rating of 800V and will pass a maximum average forward current of 550mA at an ambient temperature of 50°C. The maximum forward voltage drop is 1.5V at 5A and the maximum reverse current is 10 μ A at 800V. The small size of the BY100 is an obvious advantage and allows greater flexibility in positioning the device in the receiver and in effecting a reduction of localised heating.

PCL85 a triode pentode for field timebases

The Mullard PCL185 is the new triode pentode which has been developed specifically for field timebase applications and is now being encountered in many modern television receivers. To meet the heavy demands of the output stage of present-day field timebases, the pentode of the PCL85 can deliver a peak anode current of 200mA at an anode voltage of 50V and a screen grid voltage of 170V. This rating allows timebases to be designed with small output transformers, which is of obvious benefit in low-cost receivers and is particularly important in stabilised circuits where large standing currents are required. Use of the PCL85 in present-day sets has thus provided the receiver manufacturer with greater scope for economy and simplicity in his design.

'SHORT NECK' PICTURE TUBE for slender television sets

The new Mullard picture tube, type AW47-91, has a rectangular screen with a 19-inch diagonal and a deflection angle of 110°. The flatness of the screen offers a wide viewing angle and freedom from distortion when viewed obliquely. Electrostatic focusing is used and the focusing lens is of the 'unipotential' type—that is, the two outer grids of the three-grid lens are at the same potential. This type of lens prevents deflection defocusing and thus ensures good spot quality over the whole picture area. No ion-trap is used with the AW47-91 so that the problem of interaction between the fields of the ion-trap magnet and the deflection coils is absent and there is a consequent improvement in spot quality.

The design of the electrode structure of the gun of the AW47-91 is such that a very short gun has been achieved. In addition to this, the sealing pip at the base of the gun is very small, so that the total length of the tube neck is only 110 mm. The overall reduction in the length of the AW47-91 resulting from these features

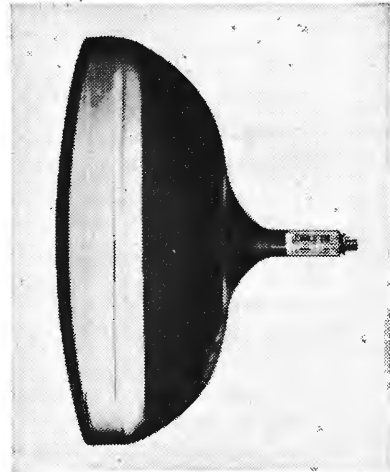

has made possible even greater reductions in the depth of television cabinets, leading to the more slender appearance of present-day sets, and offering more scope for the development of compact television portables.

MINIATURE FOIL CAPACITORS

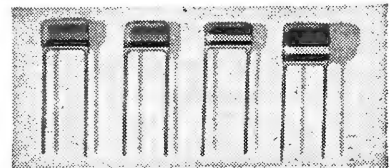

A completely new type of capacitor has been developed by Mullard to meet the demand for small components in portable transistor radios. Four values of capacitance are available: 0.01, 0.022, 0.047 and 0.1 μ F. These are the values most commonly required for decoupling in the r.f. and i.f. stages of the receivers.

These miniature components consist of a non-inductive winding using a plastic dielectric and finally coated with an insulating lacquer. The loss factor of these capacitors is less than half the loss factor of ceramic disc capacitors. Their operating temperature range is wide, and the change in capacitance with temperature is considerably less than that ex-

perienced with high-k ceramic materials. The stability of the new components is good, and the change in capacitance during working life does not exceed 10%.

In addition to the excellent electrical properties, the new foil capacitors offer certain physical advantages. Their small size, rectangular shape and insulating coating enable them to be packed closely together on printed-wiring boards, thus effecting the economy of space so vital in the design of modern pocket portables.

Watch next month for more information from Mullard about *What's New in the New Sets.*

MVM 272

Measuring Noise

IN this issue "Cathode Ray" discusses the difficulties of correlation between objective measurements of sound and the subjective reactions of human beings to it. Even under laboratory conditions and using continuous pure tones the relation between frequency and pitch, and between intensity and loudness are hard enough to define. When complex tones containing harmonics are used, and even more so when we are considering music or the common sounds of everyday life, the gulf between objective and subjective assessment becomes increasingly difficult to bridge. As "Cathode Ray" points out, the problem can be solved only by a statistical approach and on the widest possible basis.

When regulations for the control of noise are to be given the force of law the statistical sample must be as large and varied as possible: one would not place too much reliance on the results of traffic noise tests based on the opinions of the members of a motor-cycle racing club, or for that matter on those of the young ladies of a film unit who, we are credibly informed, happened to be on location near the site of a recent traffic noise test on one of our trunk roads, and who agreed to assist. Legislation can hope to satisfy only that legal fiction the "reasonable man," and to find him the sampling must be sufficiently diverse to ensure that abnormal sensitivity or ataraxia does not unduly influence the final result.

With the growing volume of motor traffic and the noise that goes with it, renewed efforts are being made throughout the world to find an equitable basis for legislative control of vehicular noise. In the United Kingdom the National Physical Laboratory and other bodies have been called in to advise the Minister of Transport. The Motor Industry Research Association has also undertaken work to determine the best methods of measuring vehicular noise as a first step to controlling it.

Some interesting facts have already emerged. It has been found that discrepancies between the judgment of annoyance and the readings of a standard (weighted) sound level meter are not as wide as might be expected. If ascending categories of annoyance are plotted against sound intensity level in dB the relationship is found to be linear and the scatter of points about a mean is never more than 10 dB wide. Estimates of the upper limit of tolerance are somewhat wider and range from 90 dB in America to 75 dB in Switzerland with, characteristically, an intermediate value of 80 dB in the U.K.

So the standard noise level meter will serve at least to sort the sheep from the goats on main roads

in the open country, but would it provide information that would stand cross-examination if used in built-up areas where the environment might be held to have increased meter readings by reverberation?

Tests for the type-approval of new cars and the checking of old ones have been devised, and they usually involve acceleration between specified speeds and over given distances with respect to the microphone of the sound level meter; but as far as we know they have not so far taken into account the noise from silencer resonances on overrun, which in some vehicles can exceed the normal exhaust noise.

Clearly international agreement is necessary in these days of foreign travel and common markets and it is to be hoped that the findings of the International Standards Organization on this matter will prove to be acceptable and workable. But they must of necessity be interim measures, dictated by the need to do at least something now to reduce the stresses of traffic noise. There is still much work to be done to produce improved measuring equipment which takes fully into account such factors as intermittence and has the ability to scan the noise in time and to select those elements which give cause for annoyance.

The "Physical Society" Exhibition

THE first report of a Physical Society Exhibition to appear in this journal was more than 50 years ago (January 1912, p. 15). It was, even at that early date, the seventh annual exhibition of "Electrical, Optical and other Physical Apparatus" and it included commercial wireless instruments such as the Marconi magnetic detector, wavemeter and decremeter. Since the beginning the organizers have striven to preserve the atmosphere of what the Victorians described as a "science meeting" and to ensure that the Exhibition shall not become too commercial. The Council of the Institute of Physics and the Physical Society, who now jointly run the exhibition, have reiterated their intention "to preserve and enhance the unique nature of the Annual Exhibition as a scientific occasion rather than an opportunity for display of ordinary commercial products."

In these days research workers and manufacturers are becoming increasingly interdependent; the one for the equipment necessary to carry out investigations which have long left the "bent wire and sealing wax" stage, and the other for fresh ideas for new products. The "Phys. Soc.," as at present constituted, enables all interested parties to meet on equal terms. May it long continue to do so.

Transistors in Space

CIRCUITS USED FOR INSTRUMENTATION AND TELEMETRY

By L. H. BRACE*

UPPER-ATMOSPHERE and space probes have required the development of new circuits to perform the various tasks of voltage generation, current detection, timing, calibration, and telemetry. In the past, such tasks were performed by vacuum-tube devices. However, due to the limited volume and energy available for the instrumentation in high-altitude sounding rockets, circuits using solid-state devices have decided advantages.

The use of solid-state circuitry eliminates need for filament power, reduces the problem of heat dissipation, and increases reliability.

Current Detectors

The need for "direct-current" detectors—to convert a slowly varying current of very low value (a few microamperes) into a voltage suitable for telemetry—occurs frequently in space research.

The semiconductor current detector shown in Figs. 1 and 2 utilizes a diode modulator as an amplifier of a.c. in conjunction with a bridge-rectifier demodulator. The modulator is a ring-type using four silicon diodes, two miniature transformers, and a unijunction transistor oscillator (V1), running at 2kc/s, as the carrier or reference generator for the modulator.

On alternate half cycles of the carrier, D1 and D2, D3 and D4 become forward biased. This alternately completes a path for input d.c. to flow through the upper half, then the lower half, of the primary of T₂. A full-wave chopping of the input carrier results, which produces a square wave of the modulator frequency at the secondary of T₂. This is the output of the amplifier; the amplitude of this square wave is proportional to the magnitude of the slowly-varying input current.

The amplifier is a high-gain miniaturized circuit. Its output is coupled to the bridge rectifier by means of step-up transformer T₃. The rectified output is filtered by a low-pass network consisting of C₅, C₆ and R₆, providing a direct output voltage proportional to the bridge-biasing current at its input (Fig. 3).

Voltage-controlled Oscillator

Several factors indicate the type of oscillator circuit best suited for a voltage controlled oscillator use:—
 (a) The available space requires a volume of less than about 0.5in³.
 (b) Low current consumption (less than 5mA) from

* Static Devices Co., El Paso, Texas, U.S.A.

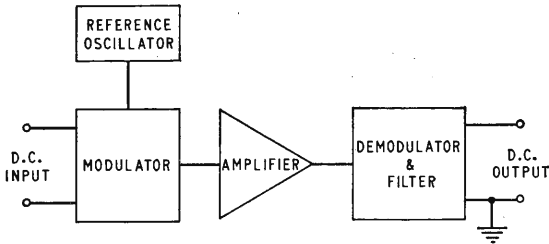
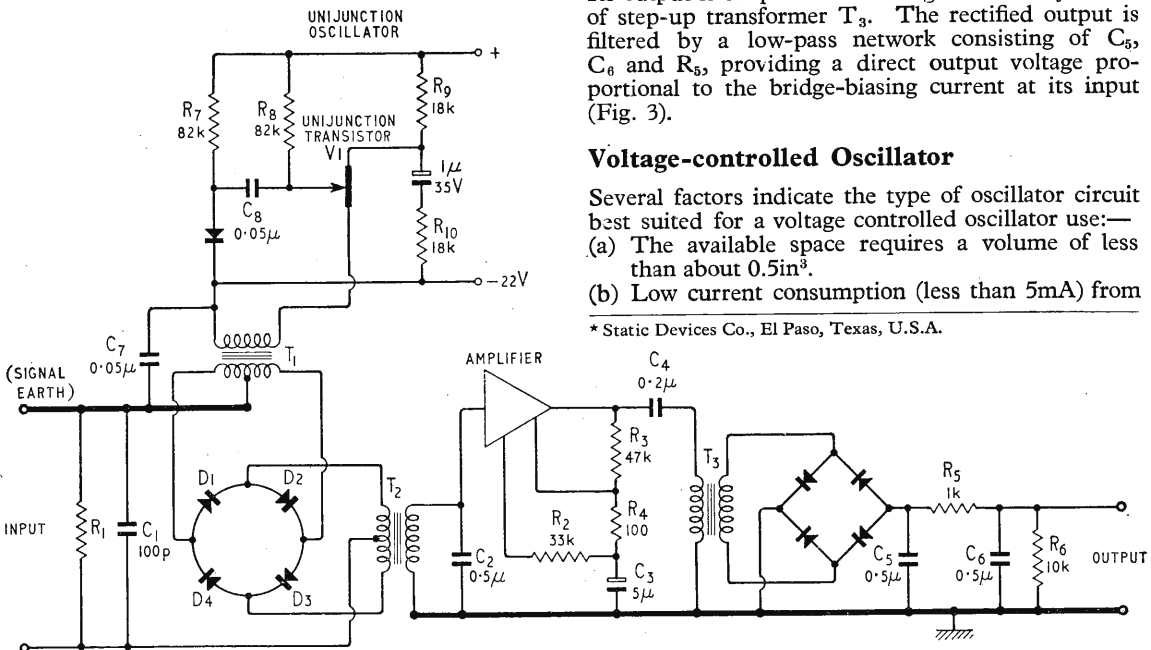

Fig. 1. Scheme for obtaining stable amplification of a very small d.c.

Fig. 2. Ring modulator/amplifier/detector circuit corresponding to block diagram Fig. 1. Note that R₄ sets a.c. gain of amplifier. Component values given apply to American semiconductor devices used by author.



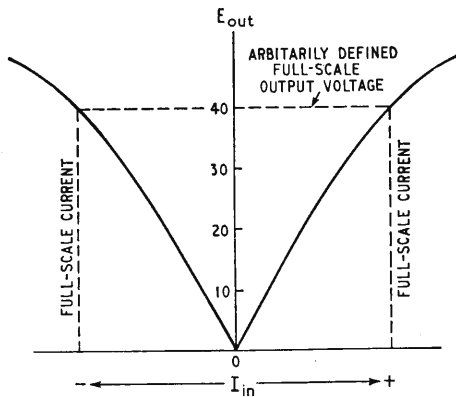

Fig. 3. Input/output characteristic of Fig. 2. As demodulator is not phase-sensitive reverse-polarity but equal-amplitude inputs give outputs of one polarity only.

the power-supply battery would make possible use of batteries of relatively small volume.

- (c) A high input impedance is desirable to prevent possible loading of the driving source.
- (d) A linear relationship between frequency and input voltage would simplify data recovery.
- (e) The frequency must be relatively independent of ambient temperature and supply voltage changes.
- (f) The required deviation of the subcarrier frequency is high—say 7.5% of the centre frequency of the channel used.

A transistor multivibrator is chosen because it can be made to conform to these requirements by using silicon transistors and fairly simple temperature-compensation techniques. Also, the multivibrator is inherently dependable in starting, uses smaller components than a comparable audio L-C oscillator, and has a relatively low output impedance so that its frequency is relatively unaffected by the load. However the multivibrator suffers from the disadvantage that its output is a square wave which must be filtered in some manner to remove the high harmonic content.

Fig. 4 shows the oscillator circuit. The bias level

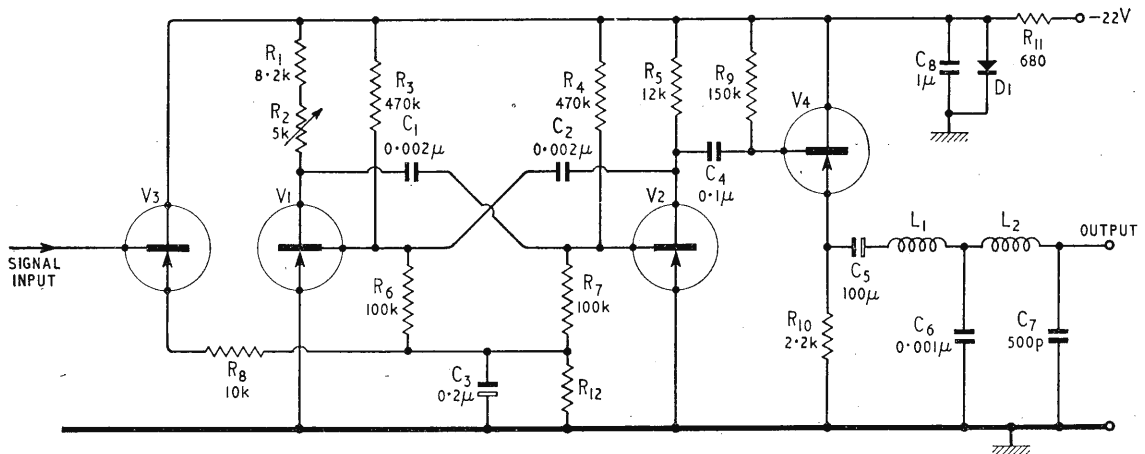

Fig. 4. Voltage-controlled oscillator circuit for conversion of varying voltage into varying frequency.

of silicon transistors V1 and V2 is set by R_3 and R_4 respectively. By conventional multivibrator action, V1 and V2 alternately conduct and cut off, producing a square-wave output at each collector.

Transistor V3 is used as an emitter follower, providing the unit with a high-impedance input of about $400k\Omega$. The input signal is applied to the base of V3 and appears at the emitter. The voltage divider R_8 and R_{12} supplies a pre-determined portion of this as a change of bias of V1 and V2, causing a change in frequency of the oscillator. Fig. 5 shows a typical curve of oscillator frequency versus input voltage. This illustrates that the curve is nearly linear within the band, and maintains reasonable linearity up to twice the full-scale input voltages (about 8V). V4, another emitter-follower stage, provides a low output impedance and avoids any difficulties that might be caused by loading of the output affecting the functioning of the oscillator. The filter formed by L_1 , C_6 , L_2 and C_7 removes the high harmonic content, so making the output an approximation to a sine wave.

Range-changing Circuit

The range-changing circuit is a high-current-gain silicon semiconductor amplifier designed to energize a relay when the circuit input voltage reaches a predetermined d.c. level (switching point). When used for space-probe instrumentation, the relay contacts are connected in an appropriate manner to add a shunting resistance at the input of the current detector and thereby change its current sensitivity.

When the input voltage (Fig. 6) is below the Zener region of reference diode D1, virtually no base or collector current flows in V1. Then the collector of V1 and the emitter of V2 are both at the supply potential ($-22V$), resulting in zero current through the relay coil.

As the input voltage approaches the switching point, D1 approaches its breakdown voltage and begins to allow V1 base current. The resulting collector current drops the collector voltage and D2 approaches its Zener region, allowing V2 to pass base current. At the switching point, the relay current reaches its pull-in value and switching occurs.

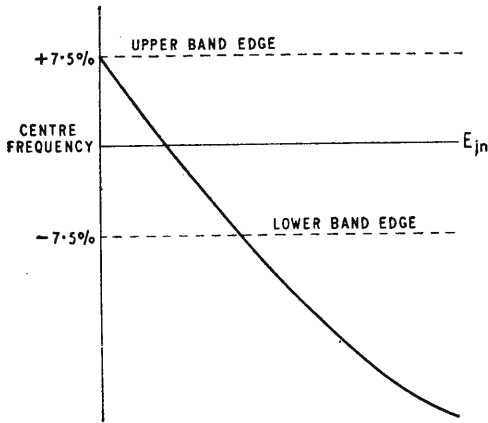

Fig. 5. Type of input/output characteristic given by circuit of Fig. 4.

Fig. 7 shows a typical curve of relay current versus input voltage. The steep slope ensures an accurately defined switching point. The relay current levels out at about 20mA (over twice the pull-in value) when the limited supply voltage no longer allows V2 collector current to follow the increases in base current.

Sawtooth-voltage Generators

Two sawtooth-voltage generators have been developed for use in probe instrumentation.

Fig. 8 illustrates one circuit—which supplies a clipped sawtooth waveform output, sweeping through a maximum range from -7 to +7V with an output voltage divider arranged to provide amplitudes of ± 2.2 and $\pm 6V$.

The emitter output of a uni-junction oscillator provides a sawtooth waveform at a frequency determined mainly by C_1 and R_3 . This output is amplified by V2 and directly coupled to the emitter follower stage V3 which provides a low-impedance output. Zener diode D2 establishes

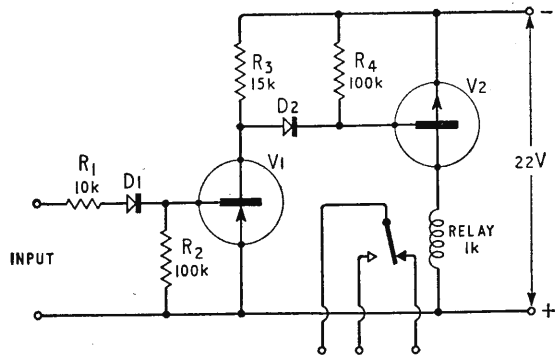

Fig. 6. Range-changing circuit. Relay contacts switch circuit constants when preset level of input volts is reached.

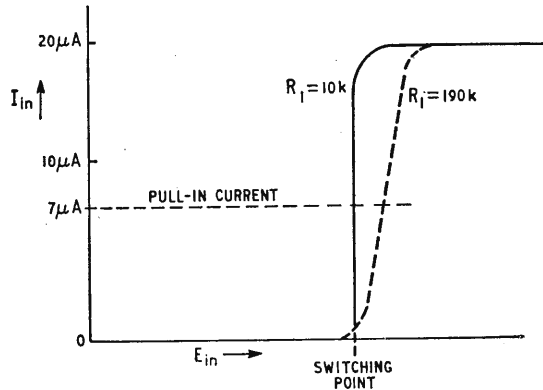

Fig. 7. Performance of range-changing circuit.

the zero reference so that the output waveform varies equally above and below zero with the emitter of D_1 taken as zero reference.

The sawtooth output is clipped at both extremes to provide known reference levels and to maintain amplitude stability independent of supply voltage and temperature changes. The clipping circuit uses

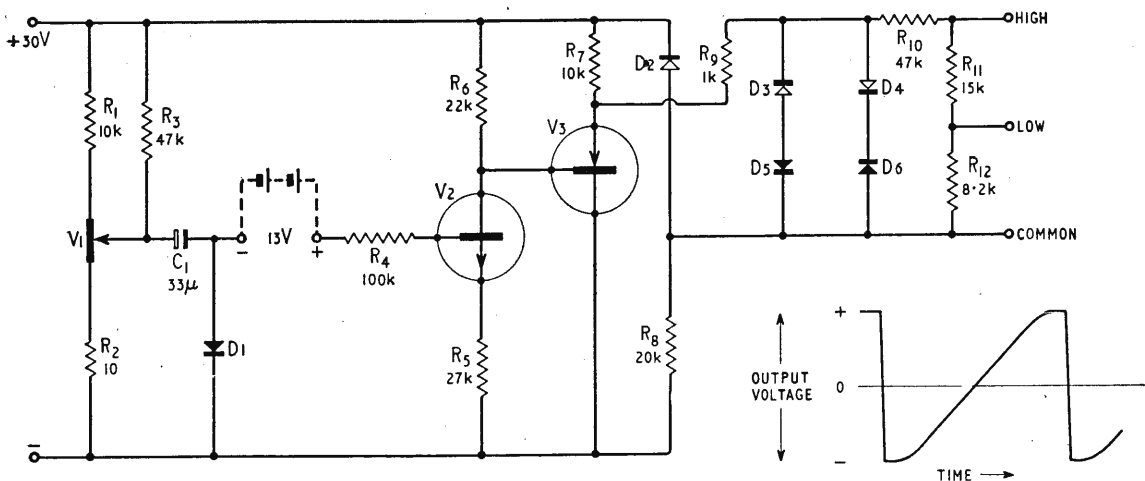

Fig. 8. Sawtooth generator providing reference levels set by Zener devices at start and finish of stroke.

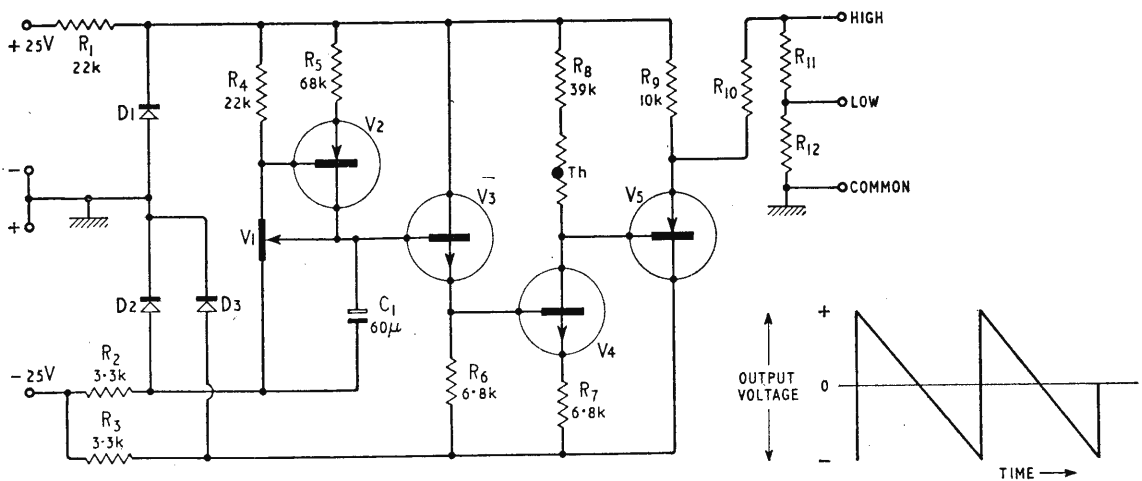

Fig. 9. Good-linearity sawtooth generator employing constant-current charging for sweep capacitor C_1 .

a silicon Zener diode (D3 and D4) for each output polarity, and a germanium diode (D5 and D6) for each Zener diode to prevent shorting of the output during forward conduction of the Zener diode. This provides the output waveform shown in Fig. 8.

The second sawtooth generator (Fig. 9) accomplishes the more difficult task of producing a pure sawtooth-waveform output having extremely good linearity, amplitude stability, and freedom from drift of the waveform about the zero reference. Furthermore, if the output is to be symmetrical about ground, this circuit may use power supplies having a common ground, thus eliminating need for separate batteries, as is required by the sawtooth generator shown in Fig. 8. This improved performance is obtained by using the more expensive silicon semiconductor devices and by requiring both a negative and positive power supply source.

Good amplitude stability, eliminating need for clipping, is the result of two features of this circuit. The supply voltages are Zener-diode-regulated to reduce bias level changes due to drift in the voltage source and the use of a silicon transistor and thermistor in the amplifier stage reduce drift in bias level due to temperature changes.

The sawtooth output of the unijunction and transistor oscillator circuit (V1, V2) is coupled to the emitter-follower stage V3 which isolates the oscillator from the input impedance of amplifier V4. Emitter-follower stage V5 presents a low output impedance to the load. V2 is a pnp silicon transistor which acts as a constant-current generator in charging C_1 , resulting in a more linear sawtooth output. Zener-diode regulators D2 and D3 are selected so that their differences in Zener voltage provides sufficient bias for V2, therefore for V3, to allow maximum output without significant distortion of the output sawtooth.

The thermistor is selected to minimize changes to output amplitude with temperature changes. Amplitude stability better than 1% can be obtained through the range of 0 to 80°C.

The maximum output amplitude is about 25V peak-to-peak, or 12.5V with respect to ground. R_7 and R_8 are adjusted to provide necessary voltage amplification for a given silicon transistor used for

V3. Supply voltage changes of $\pm 25\%$ cause less than 1% amplitude change and zero drift.

A typical output waveform is shown in Fig. 9, the linearity tolerance is reduced to less than 2% by the use of silicon transistor V2.

CLUB NEWS

Barnsley.—Meetings of the Barnsley & District Amateur Radio Club, which was formed in 1913, are held on the second and fourth Friday in each month at the King George Hotel, Peel Street, Barnsley. At the meeting on March 23rd J. Kruse will speak on "Hi-Fi Speakers."

Bexleyheath.—Dr. A. C. Gee (G2UK), honorary secretary of the British Amateur Radio Teleprinter Group, will talk to members of the North Kent Radio Society on "RTTY," as radio teleprinting is colloquially called, on March 22nd. The club meets at 8.0 at the Congregational Hall, Clock Tower.

Birkenhead.—A lecture-demonstration on a transistor direct-on-finding receiver will be given by L. Roberts on March 7th to the Wirral Amateur Radio Society. On the 21st the club is holding a constructional contest. Meetings are held at the Guide House, Ball's Road.

Birmingham.—A Mullard film meeting has been arranged by the Slade Radio Society for March 9th. The films are "Particles Count!" and "Transistors." Tickets are obtainable from D. S. Chapman, 2 Orchard Road, Erdington, Birmingham 24. Meetings of the Society are held at 7.45 at The Church House, High Street, Erdington.

Bradford.—Audio amplifier design and construction will be discussed by P. L. Barowitz (G3LZW) at the March 13th meeting of the Bradford Radio Society. The club meets on alternate Tuesdays at 7.30 at 66 Little Horton Lane.

Halifax.—Mobile operation will be discussed by H. Brooke (G3GJV) at a meeting of the Northern Heights Amateur Radio Society on March 21st. Meetings are held at 7.45 at the Sportsman Inn, Ogden.

Prestatyn.—J. T. Lawrence (GW3JGA/T), the chairman of the Flintshire Radio Society, will demonstrate amateur colour television transmission at the meeting of the club on March 26th. Monthly meetings are held at 7.30 at the Railway Hotel.

Southampton.—At the meeting of the Southampton Group of the R.S.G.B. on March 10th G. M. C. Stone (G3FZL) will talk about v.h.f. transmitters. The group meets in the Lancaster Building of the University at 7.0.

Spenn Valley.—The March programme of the Spenn Valley Amateur Radio Society includes a talk on radio astronomy on the 14th by L. Dougherty, of the Halifax Technical College, and another on single-sideband operation (28th) by A. W. Walmsley (G3ADQ). Fortnightly meetings are held at 7.30 at the C. of E. Infants' School, Hill Top, Gomersal.

HARMONIC ANALYSIS

GRAPHICAL METHODS DESCRIBED

By H. C. PARR, M.A

THERE are several arithmetical methods for analysing a repetitive waveform into its component harmonics, and hence of deriving the first few terms of its Fourier expansion, but if more than the first two or three terms are required the work is very laborious.

Where a high degree of accuracy is not wanted, results can be obtained much more quickly and pleasantly by graphical methods. It is possible to devise a wide variety of such methods, and which of these are the most useful in any particular case depends upon the number of terms required, the rapidity with which the series converges, the degree of accuracy expected, and whether the final results are to be expressed numerically or graphically. It is possible to describe in this article only a limited number of such methods, and these have been chosen on the assumptions, (a) that the results are ultimately required in numerical form, and (b) that the type of waveform being analysed is that

ical treatment. If a_1 and b_1 are known, and the point (b_1, a_1) is plotted on rectangular co-ordinates, as shown in Fig. 1, then OP represents c_1 and angle POX is ϕ_1 . In this way c_1 is derived by drawing, and without calculation.

Note that the a 's and b 's may be either negative or positive, but that the c 's can all be taken as positive.

The Sine-wave: Consider first a simple wave which involves only a single frequency. The curve can be expressed as

$$y = b_0 + a_1 \sin \theta + b_1 \cos \theta,$$

and one cycle is shown in Fig. 2. The values of b_0 , a_1 , and b_1 are readily found on this diagram if the 90° and 180° ordinates are drawn as shown. The y -values of B, A and C are clearly $b_0 + b_1$, $b_0 + a_1$, and $b_0 - b_1$ respectively. So if BC meets the 90° ordinate at Q, then the y -value of Q is b_0 . A horizontal line RQ can then be drawn through Q, and RB must represent b_1 , and QA must represent a_1 , the sign, of course, being negative if B or A lie below the line RQ.

Constructing a Mean of Two Curves: In dealing with more complex waveforms, an important technique is the construction of the *mean* of a pair of superimposed curves. With a little practice this can be done speedily as shown in Fig. 3. Each point is plotted by laying the ruler along an ordinate with its "O" mark on the lower curve, and mentally halving the distance between the two curves on this particular ordinate, as shown in the figure. It is not necessary for these ordinates to be equally spaced; points need to be plotted fairly closely only when one or other of the curves is changing direction rapidly. The plotted points are then joined with a curve in the usual manner, using a broken line, or some other feature, to distinguish it from the original two curves. This curve is the required mean.

Separation of Odd and Even Harmonics: By using the above technique it is possible to separate the odd and even harmonics from a complex wave. Consider, for example, Fig. 6, which shows one cycle of a sound wave. Firstly, a tracing is made of the complete waveform, marking for reference the horizontal axis and the 0° , 180° and 360° ordinates, and printing "TOP" in appropriate position on the tracing paper. This is then turned over, and instead of scribbling, all the lines are carefully repeated on the back, so that they will print through when required, and furthermore, will do so either from front to back or from back to front.

In order to isolate the odd harmonics, a complete copy is made of the tracing. The tracing paper is then turned over about a horizontal axis so that the "TOP" mark is at the bottom, but left and right are not interchanged. With the tracing in this position the *right* half of the curve is then superim-

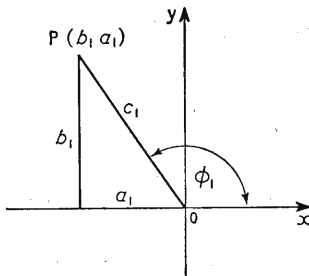

Fig. 1. The construction for obtaining amplitude and phase of c_1 .

encountered in studying the harmonic structure of sounds produced by musical instruments.

The Fourier Expansion: The most usual form of the Fourier expansion is:

$$y = b_0 + a_1 \sin \theta + a_2 \sin 2\theta + a_3 \sin 3\theta + \dots + b_1 \cos \theta + b_2 \cos 2\theta + b_3 \cos 3\theta + \dots$$

and it is in this form that we shall obtain our results.

An alternative form is:

$$y = b_0 + c_1 \sin(\phi_1 + \theta) + c_2 \sin(\phi_2 + 2\theta) + c_3 \sin(\phi_3 + 3\theta) + \dots$$

and this is more useful in some cases, being expressed directly in terms of the amplitudes and phase angles of the individual harmonics. If the results are required in this form, they can be derived from the first form equation by using the following relations, which are not difficult to prove:

$$c_1^2 = a_1^2 + b_1^2 \text{ etc.,}$$

$$\text{and } \tan \phi_1 = b_1/a_1 \text{ etc.}$$

These formulae lend themselves readily to graph-

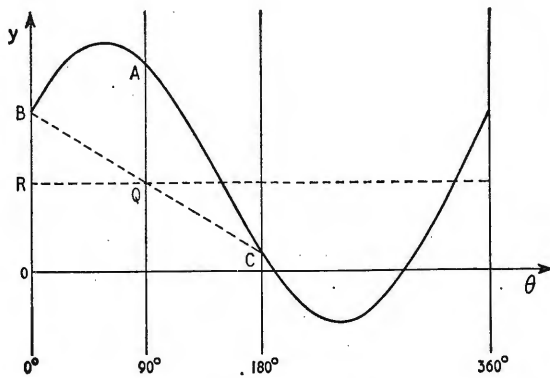

Fig. 2. The construction for a_1 and b_1 .

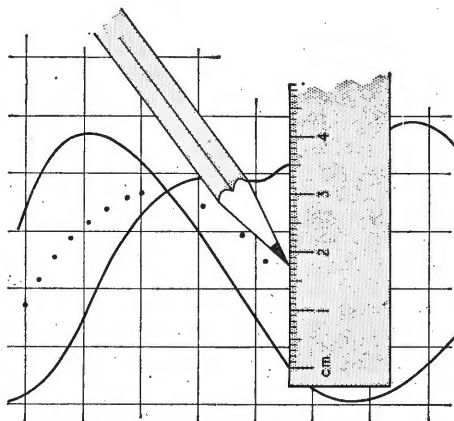

Fig. 3. Plotting a mean curve.

posed on the *left* of the original, and the *left* half superimposed on the *right* of the original, as shown in Fig. 7, taking care that the horizontal axis and the appropriate ordinates are in register during each operation. The mean of these two curves is then drawn, and this curve, shown by the broken line in Fig. 7, contains all the odd harmonics of the original wave, and none of the even.

To obtain, the even harmonics, only half the curve need be printed through in the first instance, from 0° to 180° , and on top of this the other half, from 180° to 360° , is superimposed, this time without inverting the tracing paper. The mean of these two curves is then drawn and contains only the constant term b_0 (which is conveniently referred to as "harmonic No. 0") and the even harmonics. This is shown in Fig. 8.

Method of Superimposition: A similar, but more elaborate, method can be used to isolate other groups of harmonics. Suppose we divide the tracing of Fig. 6 into three equal parts by drawing the 0° , 120° , 240° and 360° ordinates, and superimpose the three sections of the curve on one diagram as shown in Fig. 4. It is then possible to draw the sum of these three curves. A number of spaced ordinates are drawn as shown, and a point is plotted on each of these by adding the y -values of the three curves on this particular ordinate, using compasses to step

off the distances, and bearing in mind that the values may be either positive or negative and must be added algebraically. One must be systematic over this, and a suggested method is as follows: starting with the compass point on the horizontal axis step off the height of the uppermost curve on this ordinate. The quantity represented by the compass will then be positive if the pencil is above the point, and negative if it lies below, and this rule applies throughout the operation. To add the ordinate of the second curve, move the compass *without turning* so that the pencil is on the horizontal axis, locate the point (still on the same ordinate), and open or close until the pencil is on the second curve. (It may be necessary to turn the compass through 180° , and this merely signifies that the addition has changed the sign of the quantity represented by the compass.) Deal with the third curve in the same way, remembering always to return the pencil point to the horizontal axis before altering the compass setting. The final setting is now stepped off upwards or downwards as the case may be, with the compass point now on the horizontal axis and a mark made, showing a point on the required summation curve. This is shown in Fig. 4.

What does this summation curve represent? In the present case it contains only the harmonics Nos. 3, 6, 9, etc., together with No. 0. In general terms the result of dividing a curve into n sections, superimposing, and drawing the summation curve, is to isolate harmonics, $0, n, 2n, 3n$, etc. But note carefully that the scale on which these harmonics are represented is magnified n times. This means that the broken curve on Fig. 4 would give harmonics 3, 6, etc., on a scale three times the original.

The usefulness of this process will be at once apparent. In many cases the terms $2n, 3n$, etc., are negligible, and the resultant curve will represent very nearly the n th harmonic alone, together with the constant term. Further, if the process is applied to a curve which has already had the even harmonics removed, n itself being an odd number, then only harmonics $n, 3n, 5n$, etc., are present. However, the process is timetaking, and the method to be described subsequently, although it has disadvantages, will be preferred when it can be applied without too great a sacrifice of accuracy.

Use of a "Grid": This method gives a_n and b_n directly, but can be applied only if it is known (a) that there is no constant term, and (b) that all harmonics of frequencies $2n, 3n$, etc., are either non-existent

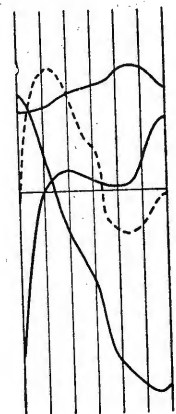

Fig. 4. Plotting the sum of three curves.

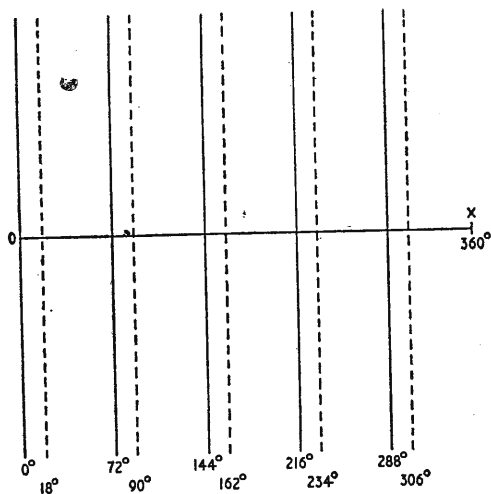

Fig. 5. Grid for the isolation of the fifth harmonic.

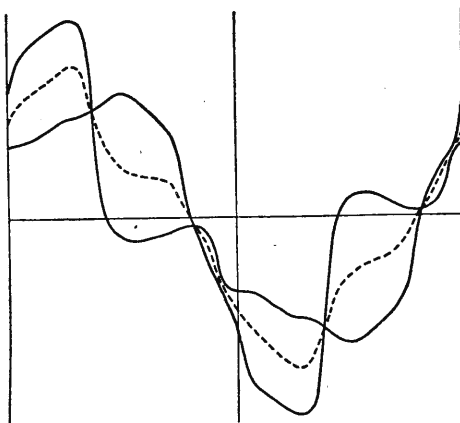

Fig. 7. The broken line contains the odd harmonics.

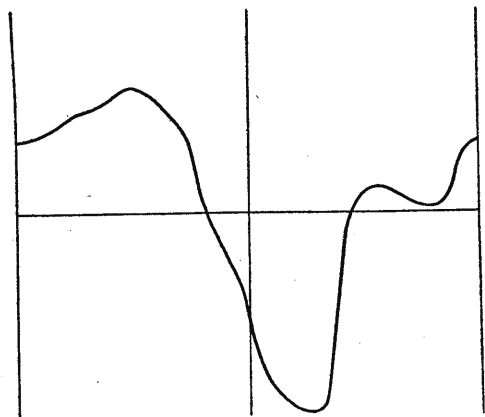

Fig. 6. The waveform to be analysed.

(e.g., because they have already been removed) or are negligible. The technique involves the preparation of a "grid" on tracing paper, but if it is applied frequently it is remarkably quick once the grid has been drawn.

It is necessary to decide in advance on a standard scale for the horizontal axis. When working on foolscap or quarto paper a suitable scale would be 18 cm to represent the full 360°, while double this scale would be convenient for larger drawings. If it is not convenient to use mechanical contrivances for increasing or decreasing a given waveform to standard scale, it is possible to do this freehand with sufficient accuracy if a network of squares is drawn on the given diagram, their size being such that they will become, say, 2 cm squares on the standard scale diagram. The vertical and horizontal scales will be changed, of course, in the same ratio.

Fig. 5 shows the grid needed to isolate the fifth harmonic. The cycle is divided into five equal sections, and a full vertical line drawn at the start of each section, and a broken vertical line one-quarter of the distance along each section. If this grid is placed in position over a waveform drawn to the correct horizontal scale, with the line OX along the

horizontal axis, then the *average* of the *y*-values of the curve on the five full lines is equal to b_5 , and on the five broken lines is a_5 . These averages are obtained by adding the appropriate *y*-values with compasses, exactly as detailed earlier in the article, stepping off this sum along any convenient line, measuring, and dividing the result numerically by five. These results may, of course, be either positive or negative, but the sign may be ignored if only the amplitude, and not the phase, is required. To find the phase, a_5 and b_5 can be stepped off along a pair of perpendicular lines, and the diagonal measured as explained earlier, and shown in Fig. 1.

An analogous method can be used for any harmonic, and no further explanation will be needed.

Typical Application: We shall illustrate the use of all these methods by analysing the curve of Fig. 6 as far as the eighth harmonic. From the general appearance of the curve it is clear that no higher harmonic is unduly prominent. While those of higher order than, say, the twelfth, may be completely disregarded, it is advisable not to assume, for example, that the ninth is sufficiently small to have no effect on the third, if we use a method which fails to separate the two.

The stages in the analysis will be as follows:

- (1) Reduce the given curve to standard scale. Fig. 6 is assumed to be already in this form.
- (2) Prepare grids for the fifth, sixth and seventh harmonics.
- (3) Trace Fig. 6. By using the methods described obtain the odd harmonics on Fig. 7 and the even harmonics on Fig. 8.
- (4) Mark the 90° ordinate on Fig. 8 and trace the broken curve. By a complete repetition of process (3), obtain on Fig. 9 the harmonics 2, 6, 10, etc. (i.e., the "odd" even numbers) and on Fig. 10 the harmonics 0, 4, 8, etc. (i.e., the "even" even numbers).

(5) Trace the broken curve of Fig. 10 and repeat process (3) yet again, to give on Fig. 11 harmonic 4, and on Fig. 12 harmonics 0 and 8. Note that Fig. 11 will contain also the twelfth harmonic, but that the effect of this can be largely eliminated by making the broken curve not the best one that can be drawn through the plotted points, but the best *sine curve*, as judged by the eye. Drawing the 22½° ordinate

will then enable a_4 and b_4 to be measured. If Fig. 12 is too small to apply the construction illustrated in Fig. 2, the axis of the sine curve can be drawn in by eye, giving b_0 , and after marking the $11\frac{1}{4}^\circ$ ordinate, a_8 and b_8 can be found.

(6) Find a_6 and b_6 by applying the appropriate grid to the resultant of Fig. 9.* Note the advantage of using Fig. 9 rather than the original waveform, which may contain twelfth harmonic.

(7) Apply the appropriate grid to the resultant of Fig. 7 to determine the fifth harmonic.

(8) Apply the appropriate grid to the resultant of Fig. 7 to determine the seventh harmonic.

(9) Trace the broken curve of Fig. 7, mark the 120° and 240° ordinates and use the method of

* Only half the grid will be needed, and the totals will, of course, be divided by three, not six.

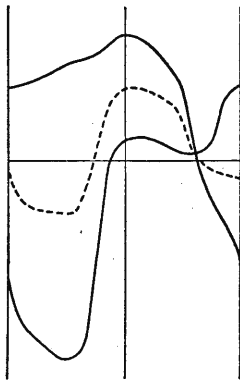

Fig. 8. The broken line contains the even harmonics.

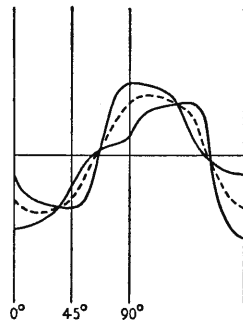

Fig. 9. The "odd" even harmonics, i.e., 2, 6, 10, etc.

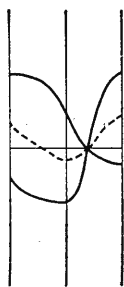

Fig. 10. The "even" even harmonics, i.e., 0, 4, 8, etc.

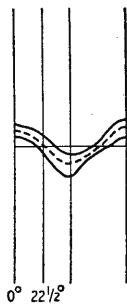

Fig. 11. Harmonic 4.



Fig. 12. Harmonics 0 and 8.

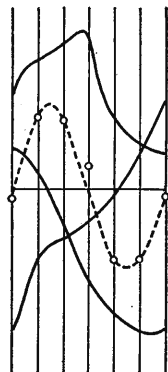

Fig. 13. Harmonic 3.

superimposition to derive the third harmonic as shown in Fig. 13. We use this method rather than the quicker "grid" method because of the possible effect of the ninth harmonic. This can be allowed for in Fig. 13 by drawing the best sine curve through the plotted points. (Do not forget that the a and b values derived from Fig. 13 must be divided by three.)

(10) If the 45° ordinate is now drawn on Fig. 9 it is possible to derive the second harmonic by a numerical method. Measure the y -values of the broken curve on the 0° and 45° ordinates, and call these b and a respectively. Then it is easy to see that

$$b_2 = b - b_6$$

and almost as easy to show that

$$a_2 = a + a_6$$

(11) In a similar manner, the first harmonic can be found from Fig. 7. Using a and b to have corresponding meanings in this diagram, it can be shown that

$$b_1 = b - b_3 - b_5 - b_7$$

and

$$a_1 = a + a_3 - a_5 + a_7.$$

These are best worked out arithmetically.

This completes the analysis.

PUBLIC ADDRESS SHOW

THE 14th annual exhibition of the Association of Public Address Engineers, will be held at the King's Head Hotel, Harrow-on-the-Hill, on March 7th from 10.0 to 6.0. During the exhibition, in which about 20 manufacturers are participating (see list below), there will be a number of demonstrations of new equipment, a series of technical films will be shown and there will also be a p.a. quiz with John Gilbert as chairman of the panel of experts—S. Kelly, H. Brittain, H. Warren and A. Curtis. Admission is by ticket obtainable from Alex Walker, 394 Northolt Road, South Harrow, Middx (honorary secretary of the Association) or by business card.

The new president-elect of the Association, who will be installed at the a.g.m. held during the exhibition, is David Lodge, of E.M.I.

Exhibitors include Audix, Chapman Ultrasonics, C. T. H. Electronics, E.M.I. Electronics, Film Industries, G.E.C., Goodmans, Lustraphone, Magneta, Pamphonic, Politechna (A.K.G.), Renda Instruments, Reosound, Resosound, S.T.C., Shure Electronics, Vortexion, Haydon Warren, Westrex, and Wrights (Cambridge).

R.S.G.B. "Amateur Radio Handbook"

THIS book provides a first-class course of instruction for the intending amateur operator and a gold mine of reference for those already experienced. The second edition (published 1940) was reprinted no fewer than 12 times during the period up to 1946 and proved its popularity by selling nearly 190,000 copies. Revised and re-written, the third edition has been considerably extended and contains information on the latest techniques, including a large section on single-sideband operation and equipment. Many designs for construction are included and layout diagrams and mechanical details are given where needed. It is difficult to imagine an amateur's problem that could not be solved by reference to *Amateur Radio Handbook*: it is nearly as hard to imagine a professional problem, too, at least in the communications sphere, to which the answer would not be available. There are 552 pages and over 600 figures and the book is obtainable from the Radio Society of Great Britain, 28, Little Russell Street, London, W.C.1, price 34s (by post 36s 6d).

Ionosphere Review: 1961

SUNSPOT ACTIVITY DECLINING RAPIDLY

By T. W. BENNINGTON*

SUNSPOT maximum occurred at the epoch February/March, 1958, and since then the solar activity has been decreasing. Throughout 1961 the average activity, as indicated by the 12-month running average of the monthly sunspot numbers, continued to decrease at a relatively rapid rate, so that at the end of the year the value of this index of the solar activity, which at sunspot maximum stood at 203, had fallen to 52, a considerably lower value than had been expected. The average level of ionization of the ionospheric layers, as a consequence, also continued to decrease and the higher frequencies in the short-wave band were useful for long-distance communication for only very limited periods, whilst the lower frequencies had to be used for a much greater proportion of the total time.

Course of the Sunspot Cycle.—The way in which conditions have varied throughout the present cycle is illustrated by the graphs. The upper graph is a

plot of the sunspot numbers (indicative of the solar activity) and the two lower graphs give the noon and midnight F_2 -layer critical frequencies as measured at the D.S.I.R. station at Slough (indicative of the level of F_2 ionization). The full lines in each graph give the monthly mean, or median, values, and the dashed lines show the 12-month running average of these, and thus indicate the average conditions and the general variation in each quantity.

As is seen there have, since sunspot maximum in 1958, been large fluctuations in the monthly sunspot numbers, but by the end of 1961 the value had fallen to 32. The twelve-month running average value, which had decreased relatively slowly till early 1959, has since then been decreasing quite rapidly, and that decrease was maintained throughout 1961. If the present rate of decrease, or something near it, continues in the future it would seem that sunspot minimum might occur in 1963: much earlier than it had been expected. But it is impossible to say whether, in fact, the present rate of

decrease *will* continue, and so the time of the minimum is at present uncertain. However, we can be certain that for the next few years the solar activity will be relatively low and that, consequently, the ionization of the ionosphere will be low and the higher frequencies unusable for long-distance communication.

The noon critical frequency, it is seen, was during 1961 considerably lower than during the previous years, more particularly during the winter months at the end of the year, whilst the midnight critical frequency also decreased appreciably. The implication of all this is, of course, that during the year the frequencies of use for long-distance communication decreased considerably.

Usable Frequencies.—Surprisingly enough it was found in practice that 26 Mc/s was still usable in daylight during the early part of the year, and

* Research Department, British Broadcasting Corporation

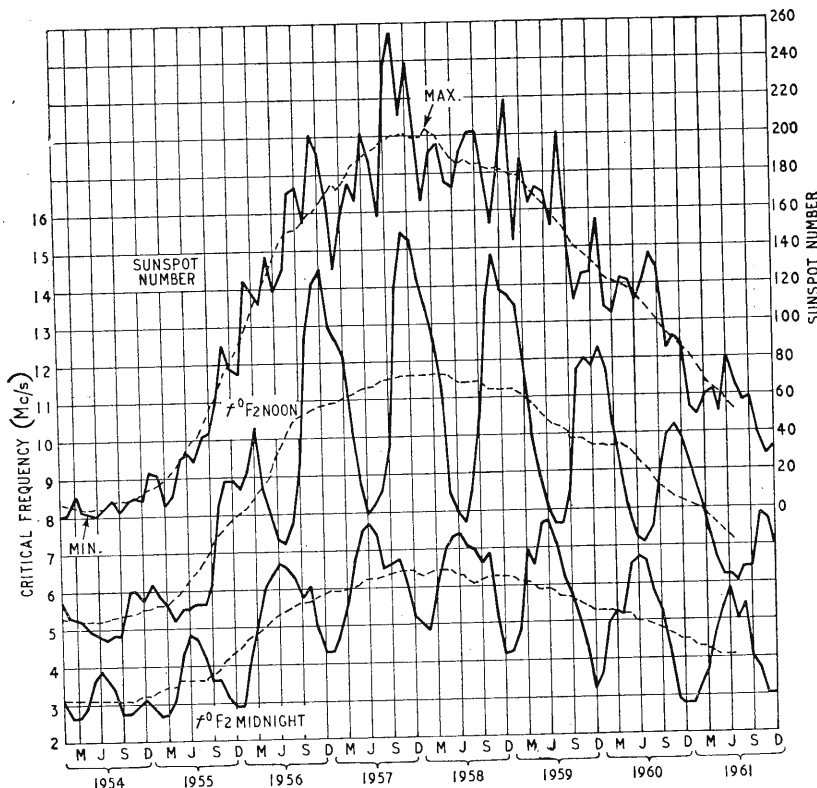

Variations in sunspot activity with corresponding variations in ionospheric conditions, 1954-1961 inclusive.

again during the autumn, though only over a few circuits running in southerly directions from this country. During the summer the highest usable frequency over these circuits was 21 Mc/s, and that for only a limited period. Over more northerly circuits 21 Mc/s was usable during the early part of the year and again, for a limited period, during the autumn, but during the summer 17 Mc/s was the highest usable. After dark during the winter there was a sharp decrease to 9 and 6 Mc/s and even lower frequencies. The highest receivable frequencies over the North Atlantic circuit which, at the beginning of the year, were of the order of 29 Mc/s, decreased to about 19 Mc/s during the summer and increased again to about 23 Mc/s during the autumn. The highest receivable frequencies for the deep night increased to about 14 Mc/s during the summer and decreased to the order of 7 Mc/s towards the end of the year. From this it is apparent that the working frequencies were considerably lower, both by day and night, at the end of the year than at the beginning.

Ionospheric and Magnetic Disturbances.—The decrease in the number of sudden ionospheric disturbances, which has gone on year by year since 1957, was continued during 1961, during which year there were relatively few of such disturbances. The number of magnetically and ionospherically stormy days, which had increased somewhat during 1960, decreased again during 1961. It is by no means certain, however, that these storms, which are caused by streams of solar particles arriving in the earth's atmosphere, will continue to decrease in number as sunspot minimum

approaches, for often, about one or two years before minimum, they seem to increase in number and intensity.

The Coming Year.—During 1962 sunspot activity will most likely go on decreasing, though it is impossible to say whether the present rate of decrease will be maintained. But it seems probable that the 12-month running average sunspot number will, by the end of the year, have fallen to a value of about 20. If this is so there will be a further reduction in the total time when the higher frequencies are usable and considerably more use will have to be made of the lower frequencies. Over southerly circuits 17 Mc/s should still be usable as a daytime frequency during the summer months, and 21 Mc/s during the autumn and winter. For night-time communication 11 Mc/s should be usable during the summer, but the highest usable frequency in the autumn and winter is likely to be 9 Mc/s, and possibly even lower. Over more northerly circuits 15 Mc/s will be about the highest daytime frequency during the summer, and 17 Mc/s next winter. It is over these circuits during darkness that things will be most difficult, for though 11 Mc/s should be usable during the summer, by autumn only frequencies of 6 Mc/s or lower are likely to give results, and on these lower frequencies the congestion of stations will, no doubt, be troublesome.

It appears, therefore, that during 1962 radio conditions will gradually approach those associated with sunspot minimum, and that, by the end of the year, they will be becoming difficult for long-distance communication particularly during the hours of darkness.

THAMES RADAR

EXTENDED COVERAGE WITH NEW INSTALLATION

THE Port of London Authority's control point at Gravesend has, for the past two years, been equipped with radar providing a complete picture of the Gravesend Reach—some 5 miles of the Thames. Now, Decca, who provided the original equipment, are to supply their Type 32 harbour radar for a second site at Cliffe, 5 miles east of Gravesend, from which the radar pictures will be fed to the P.L.A. control point via a microwave link. The combined installations will provide the operations staff of the Thames Navigation Service with a detailed view, on five display units, of all shipping movements in a 12-mile stretch of river.

It is at Gravesend where Customs and Port Health Authorities grant *pratique* and where sea and river pilots change over in the 150 or more vessels which, on an average, pass through this area every 24 hours. The Navigation Service utilizes the v.h.f. marine radio fre-

quencies to inform ships and shore authorities of shipping movements and advise masters of safe anchorages when river navigation is impracticable.

The new radar at Cliffe, where there will be duplicated transmitters and receivers, will be remotely controlled from the Gravesend Operations Room and there will normally be no need to keep the station manned. The aerial will be installed on a 70-foot lattice tower.

Radar coverage of the 12-mile stretch of the Thames from the Chapman Light, off Canvey Island, to above the Tilbury Docks will be provided on five Decca p.p.i. displays. The areas R & S are covered by the existing installation at Gravesend and U, V & W by the new station at Cliffe.

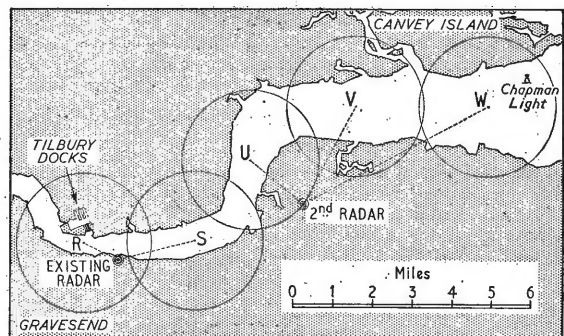

WORLD OF WIRELESS

Balance of Trade

IMPORT-EXPORT figures for 1961 issued by the Board of Trade show that the increase in the value of radio and electronics exports was over £11M whereas imports increased by only £2.7M. The overall total of exports was £68.9M and of imports £23.5M. The main increases in imports were in transmitting equipment £6.8M compared with £5.5M the year before, domestic and car receivers £1.4M (£0.6M) and industrial electronic gear £1.3M (£0.75M). There were decreases in transistor imports (£1.26M against £1.32M) and in valves and c.r. tubes (£4.4M against £4.6M).

It will be seen from the following table how the 20% increase in exports was made up:

	1960	1961
Valves, tubes and parts	7.1	10.0
Domestic radio sets and car radio	2.5	2.2
Television sets	1.0	1.6
Transmitters, nav aids, etc.	18.2	21.4
P.A. equipment, loudspeakers, etc.	1.3	1.2
Components and accessories	15.2	17.7
Electro-medical apparatus	0.5	0.5
Industrial electronic gear	2.1	2.5
Instruments and test gear	9.4	11.8
	£57.3M	£68.9M

Telecommunications Developments

SATELLITE communications, all-electronic telephone exchanges and the extension of subscriber trunk dialling were all dealt with by the Postmaster-General when speaking at the annual dinner of the Telecommunication Engineering and Manufacturing Association on February 13th. He announced that the building was complete and equipment was being installed in the ground station on Goonhilly Down, Cornwall, for the forthcoming Anglo-American tests of communications via satellites. The aerial should be completed in April and the station is planned to be operational by the late spring or early summer. On the question of the planned round-the-world telephone cable becoming outmoded by satellite communication the P.M.G. expressed the opinion that in the long term they will exist together as complementary systems.

"The first all-electronic public telephone exchange in Europe" will be brought into service at Highgate Wood, North London, later this year. The Post Office and a consortium of manufacturers have developed the new electronic system and he reaffirmed the policy that the Post Office should change to fully electronic telephone exchanges.

Audio Festival & Fair.—We are again handling tickets for this annual event which is being held at the Hotel Russell, London, W.C.1, from April 26th to 29th. Tickets, which admit two on any day excluding the trade period from 11.0 to 4.0 on the 26th, are available free of charge from audio dealers and from this office. Applicants are asked to send a stamped addressed envelope. Applications for tickets for the trade period must be made on business notepaper.

Two New B.B.C. "Satellite" Stations Open.—The B.B.C.'s new television and v.h.f. sound broadcasting stations at Redruth, Cornwall, and at Beckley, Oxford, have been brought into service. The Redruth station, which is designed to work unattended, receives its television and sound programmes by direct reception of transmissions from the station at North Hessary Tor. It re-transmits the TV programmes on Channel 1 and the sound programmes on the following frequencies: 89.7, 91.9 and 94.1Mc/s. The Beckley station, also designed to work unattended, re-transmits the television programmes from Sutton Coldfield on Channel 2. In each case both the television and sound transmissions are horizontally polarized. The v.h.f. sound radio transmitters at Beckley will be completed during the spring and will operate on four frequencies—89.5 (Light), 91.7 (Third), 93.9 (Midland Home) and 95.85 (West of England Home).

Dip. Tech. Awards.—The latest list of 374 awards of the Diploma in Technology brings the total to 1059. Among the latest list of diplomates is the first woman to receive a diploma in electrical engineering. She is Miss J. Gardner, of A.E.I. (Manchester), who studied at the Royal College of Advanced Technology, Salford, and passed with first-class honours. The total number of students following courses leading to the award is 6,200 an increase of over 1,200 on the previous year. Courses leading to the award, which is equivalent to an honours degree, comprise a 4 or 5 year sandwich course of academic and industrial training.

T.E.M.A. Awards.—For the first time since the scheme was introduced four years ago, a young woman is among the three prizewinners in the competition organized by the Telecommunication Engineering & Manufacturing Association for the best final year apprentices among its members. The prizes were presented at the Association's annual dinner on February 13th. The winners in the three categories are:—J. P. Bennett, M.Sc., graduate-in-training, of Ericsson Telephones; R. M. Morris, Dip.Tech., student apprentice, of G.E.C.; and Miss M. A. Hardman, technician apprentice, of A.T. & E.

Receiving Licences.—Last December's increase in the number of combined TV/sound licences throughout Great Britain and Northern Ireland was 23,794, bringing the total to 11,657,504. This compares with 11,076,004 at the end of December, 1960. Sound-only licences remain around the 3½M mark and last December's total was 3,658,806, including 500,253 for sets fitted in cars.

Relay Services Association.—The new president of the Association is Sir Fitzroy Maclean, Bt., C.B.E., who succeeds the late Sir Walter Womersley, who held the position from 1948 until his death last year. W. E. Brooks, of Rediffusion, and G. Parker, of Macclesfield Radio Relay Co., are respectively appointed chairman and deputy chairman for 1962.

"Trader Year Book."—Field-strength contour maps for both B.B.C. and I.T.A. television stations, condensed specifications of current receivers and tape recorders, post-war receiver i.f.s, a directory of manufacturers' addresses and buyers' guide are but a few of the many features in the 1962 edition of the "Wireless & Electrical Trader Year Book." First published in 1925, this year's 436-page volume, issued by Iliffe Books, costs 21s.

Faraday Medallist.—Sir Basil Schonland, C.B.E., F.R.S., director of the research group of the U.K. Atomic Energy Authority until his retirement a year ago, is awarded the I.E.E. Faraday Medal "for the outstanding part he has played in the development of electrical science and engineering, in particular in the field of nuclear power." Sir Basil, who was a signals officer in the first world war and between the wars was a professor of physics at the University of Cape Town, was from 1941-44 superintendent of the Army Operational Research Group in the Ministry of Supply. After the war he returned to South Africa but came back to the U.K. in 1954 as deputy director of the Atomic Energy Research Establishment.

Semiconductor Documentation.—The full text of the International Symposium on Semiconductors, held in Paris in February, 1961, and reported in this journal for April of that year, has now been published. It comprises 1,800 pages in two linen-bound volumes, the first covering production techniques and the second applications and reliability. More than 120 papers were read by leading authorities, and this text, coming after a period of intensive activity in semiconductor research, will be a valuable source of information for many years to come. Copies of the two volumes together are now available at a cost of 192 NF from S.D.S.A. (Société pour la Diffusion des Sciences et des Arts), 23 rue de Lübeck, Paris, 16e.

Physics Convention.—At the opening session of the fourth annual convention of the Institute of Physics & Physical Society at Harrogate on May 24th, Sir Bernard Lovell, director of the Nuffield Radio Astronomy Laboratories at Jodrell Bank, will deliver the 1962 Guthrie Lecture. Among the lectures on the second day of the convention, which "is intended primarily as a domestic affair," is one by Dr. A. C. Rose-Innes, of the Services Electronics Research Laboratory, on "Physics of tunnelling between superconductors."

National Gramophone Conference.—During the annual conference of the National Federation of Gramophone Societies at High Leigh, Hoddesdon, Herts, during the weekend of March 30th-April 2nd, Cecil Watts will be speaking on stereo reproduction. A new loudspeaker is to be described and demonstrated by F. R. Britten and B. J. Webb. The major part of the programme is devoted to the aesthetics of music. The conference secretary is G. E. Palmer, 106 Stratfield Road, Kenion, Harrow, Middx.

Battery Symposium.—Contributions from Canada, France, Germany, Poland and the U.S.A. are listed in the provisional programme of some 30 papers for the third International Battery Symposium which is to be held in Bournemouth from October 2nd to 4th. Details of the symposium, which is being organized by the Inter-Departmental Committee on Batteries, are obtainable from D. H. Collins, Admiralty Engineering Laboratory, West Drayton, Middx. The registration fee is 4gn.

Computer Appreciation.—Courses, designed to give the executive an appreciation of whether the work of his organization could be carried out on a computer, and if so what advantages, economic and otherwise, might be expected to result, are being conducted by Leo Computers Ltd., Partree House, Queensway, London, W.2. Each course is of one week duration and the fee is 25en. Further details are available on application to the training manager at the above address.

Automatic Control.—At the West Ham College of Technology, Stratford, London, E.15, a short evening course in automatic control, intended for graduates and holders of H.N.C. in electrical engineering or applied physics, begins on March 14th.

Radio and TV licences are no longer required in the U.S.S.R. Instead, from January 1st this year a sum equal to about three-quarters of a year's licence has been added to the price of all new sets so as to "cushion the loss of revenue to the State," to quote *Soviet News*. Licences have in the past been issued for 3-year periods at the equivalent of approximately £5 per annum for television and about 28s p.a. for sound radio.

Moroccan Television Service Starts.—The Moroccan Broadcasting System begins a television service on March 3rd using the 625-line standard. An abortive attempt at television transmissions eight years ago by a private company called Telma ended after a year's operation. Now the Moroccan Government is operating the old studios and transmitters at Casablanca and Rabat and has invested about £½M to get the service operating. Much equipment for the Casablanca station has been supplied by France and that for the Rabat station by Italy. Imported television receivers are subject to government price control. It is stated that a commission of the Moroccan Ministry of Information is examining the possibility of commercial television.

Amateur Constructors.—In addition to the two prize-winners mentioned in our report of the Radio Hobbies Exhibition (January issue) there were two awards presented for the best home-constructed equipment from amateurs outside the London area. Both went north of the border; the first to H. R. Mackie (GM3FYB) for a single-sideband exciter and the second to J. MacIntosh (GH3IAA) for an "all-band" transmitter.

Soviet Set Production Up.—According to the report of the U.S.S.R. Council of Ministers' Central Statistical Board, the number of television sets produced in the Soviet Union in 1961 was 1.95M units—an increase of 223,000 on the previous year. Similarly production of sound radio receivers and radiograms increased and reached a total of 4.2M units.

The Society of Instrument Technology has recently decided to re-group its specialized sections and has accordingly formed four new sections, namely: Measurement Technology, Control Technology, Systems Engineering, and Automation. Reason given for the change is that with increasing membership (now about 3,000) the sphere of the technical activities had grown to such an extent that further sub-division was necessary. Details of the Society's activities may be obtained from 20 Queen Anne Street, London, W.1.

Satellite Communication.—An international conference on satellite communication is to be held in London early next December with the object of providing an opportunity for the presentation of papers on, and discussion of, all scientific and technical aspects of this fast-growing field. Those wishing to attend the conference are invited to apply to the Secretary of the I.E.E., Savoy Place, London, W.C.2.

R.T.R.A.—Headquarters of the Radio and Television Retailers' Association, formerly in Goode Street, has been moved to larger premises at 19-21 Conway Street, Fitzroy Square, London, W.1. (Tel.: Euston 6040).

R.F.C.W.O.O.C.A. Dinner.—The Royal Flying Corps Wireless Operators Old Comrades' Association are to hold their annual dinner in London on March 10th. Details are obtainable from E. J. F. C. Hogg, M.B.E., 57 Hendsham Road, London, S.W.17. (Tel.: Balham 6963.)

"Automatic Tape Stop"—a correction. In Fig. 2 on p. 74 of our February issue, the right-hand relay contact (shown closed) should be connected to the top of the lamp voltage regulation resistor and not to the B.T.H. VR12-B Zener diode.

Personalities

T. H. Bridgewater, M.I.E.E., has been appointed by the B.B.C. to the post of Chief Engineer, Television, a new designation for the post of Controller, Television Service Engineering. He succeeds **M. J. L. Pulling**, C.B.E., M.A., M.I.E.E., who, as announced last month, is now Assistant Director of Engineering. Mr. Bridgewater who is 53, worked for four years with J. L. Baird before joining the B.B.C. in 1932 as an assistant maintenance engineer. When the television service started in 1936 he was appointed a senior maintenance engineer at the Alexandra Palace station. After war service in the R.A.F. he returned to the B.B.C. in 1946. He has been a Superintendent Engineer, Television, covering originally O.B.'s but more recently also the Regions, since 1952.



T. H. Bridgewater

J. A. Freer

J. A. Freer, M.A. (Cantab), A.M.I.E.E., has joined International Systems Control Ltd., as chief engineer. Since 1954 he had been with Ferranti, where he was head of the group engaged in designing computer input-output systems. Previously he was with the Bristol Aeroplane Company. International Systems Control also announce the appointments of **W. T. Lee**, B.Sc., as manager of its systems analysis group and of **R. N. Anderson**, B.A., and **John Gutzon** as chief applications engineers. Mr. Lee was previously with the De Havilland Aircraft Co. where he was at one time head of their analogue computing group, and more recently worked on industrial computer control developments. Mr. Anderson, who will deal primarily with the electric power industry, transferred to I.S.C. from the G.E.C. Applied Electronics Laboratories, Stanmore. Mr. Gutzon, who will be concerned with applications in the chemical and petroleum industries, joined I.S.C. from its American associate, Thompson Ramo Wooldridge.

E. G. Cooper, manager of Smale House, the development and workshop centre of Cable & Wireless Ltd., has retired. He started his career with Marconi's in 1919 and transferred to Cable & Wireless in 1935. He has been associated with many developments, the most recent being the automatic error correction system now used on "difficult" radio links. He is succeeded at Smale House by **F. W. Simmonds** who has been with the organization for 38 years, and for the past 15 years has been in the engineer-in-chief's department.

H. A. Masters, engineer-in-charge of the B.B.C.'s Daventry transmitting station since 1956, was appointed an M.B.E. in the New Year Honours. He joined the Corporation in 1930 after service with the Marconi Company and the G.P.O.

F. S. Mockford, until recently commercial manager of Marconi's W/T Company, which he joined in 1930, has retired from full-time service. Prior to joining the company he was for 11 years supervisor of the civil aviation wireless services at Croydon Airport. In 1935 he was appointed manager of Marconi's Aircraft Department and later deputy general manager of the company. During the war he was personal assistant to the chairman and managing director, and was commercial manager for 14 years until recently appointed to undertake special duties for the managing director. Mr. Mockford has been a council member of E.E.A., and its predecessor R.C.E.E.A., since its formation, and has three times been chairman.

J. C. Gladman, B.Sc., recently appointed manager of the Computer Engineering Department of the A.E.I. Electronic Apparatus Division, joined Metropolitan-Vickers in 1948, as an engineer in the Radio Department. He became assistant chief engineer of the Computer Department in May, 1959, and two months later, on the formation of the A.E.I. Electronic Apparatus Division, was appointed assistant manager, Computer Engineering Department.

F. Winston Reynolds, founder of Winston Electronics, of Shepperton, Middlesex, has relinquished the chairmanship and managing directorship of the company, but is remaining on the board. He is succeeded as chairman by **W. Allen Bridges**, who is the Director of European Operations of the Dynamics Corporation of America, of which Winston Electronics is now a wholly owned subsidiary. **Joseph Samuels**, for six years a member of the board of Winston Electronics, has been appointed managing director. He joined the company in 1954 after ten years with Standard Telephones & Cables, and seven years with Sunvic Controls (A.E.I.).

Leslie Cooper, Assoc. I.E.E., works manager of the Phoenix Telephone & Electric Works Ltd. for the past 12 years, has also been appointed an executive director. Prior to joining Phoenix, which is a subsidiary of Combined Telephone Holdings Ltd., he was for 15 years with the H.M.V./E.M.I. group of companies engaged on production. Well-known in amateur radio circles as G5LC, he was president of the R.S.G.B. for 1953.



L. Cooper

K. F. Russell

K. F. Russell, A.M.I.E.E., has joined Wharfedale Wireless Works as technical manager. For the past 13 years he has been with Automatic Telephone & Electric Co. where he was mainly concerned with patents.

R. J. B. Finlay, O.B.E., who, at the age of 41, recently retired from the Royal Navy with the rank of Lieutenant-Commander after 24 years service, has been appointed assistant secretary of the Electronic Engineering Association. His appointment will enable **C. W. Warner**, the recently appointed information officer, to devote his whole time to the Association's information services.



R. J. B. Finlay



C. W. Warner

Larry H. Brace, the author of the article in this issue on transistors in space, is a senior engineer with Static Devices Co. of El Paso, Texas, where he is engaged in basic research in, and development of, instrumentation systems for space travel.

Hector C. Parr, director of music at Shebbear College, Beaworthy, Devon, describes on p.106 a graphical method of harmonic analysis. He was an Exhibitor at Gonville and Caius College, Cambridge, where he obtained a 2nd class honours degree in the mathematical tripos in 1949. He had held a number of teaching posts prior to going to Shebbear College.

OBITUARY

Captain John Megarry Furnival, M.B.E., who retired four years ago as general manager of Marconi Instruments Ltd., died on February 4th at the age of 69. He joined Marconi's Wireless Telegraph Company in 1919 in the original Aircraft Department and in 1934 became manager of the Aircraft Wireless Establishment formed at Hackbridge. He later undertook research work on "beam approach" and radio steering devices. He was general manager of Marconi Instruments from 1942.

Dr. Ernest Exley Thomson, M.Sc., who for many years was engaged in the development and manufacture of photoelectric and other vacuum devices at E.M.I.'s Research Laboratories, died on January 17th at the age of 55. He joined the company in 1933 and assisted in the development of the beam tetrode valve and Emitron camera tubes. During the last war he was associated first with the development of photocells for proximity fuses, then with radar c.r.t.s. and finally with klystrons.

Lucien Chrétien who died in January, aged 62, enjoyed an international reputation as an author and technical journalist, his first articles having appeared in 1917. Since 1933 he was editor-in-chief of the French technical journal *Radio et TV*. He pioneered and patented many circuit improvements relating to frequency changing, automatic gain control, etc.

George Arthur Cheetham, A.M.C.T., M.I.E.E., managing director of Ferguson Pailin Ltd., from 1942 until his retirement in 1955, and an ex-director of Metropolitan-Vickers, has died at the age of 73. Following some years with Ferranti Ltd., Mr. Cheetham joined Metropolitan-Vickers in 1913. During the last war he was responsible for the manufacture of "George"—the automatic pilot.

R. H. Dent, a pioneer of the hearing aid industry since 1919 has died. He founded Arden Acoustic Laboratories Ltd, which recently became part of the E.M.I. Group.

News from Industry

G.E.C.-Mullard Semiconductor Link.—The General Electric Co. Ltd. and Mullard Ltd., have reached an agreement to pool their resources in the production of semiconductors. This grouping means that the two companies will have a major part of the U.K. market and will be comparable to the largest transistor manufacturers in the world. Mullard is strong on transistors for domestic radio and TV in the home sales market, whilst the G.E.C. has specialized more in semi conductors for industrial and electrical engineering applications and has contacts in the export field. Thus their activities will complement each other in the new undertaking, which is likely to take the form of a joint subsidiary company. According to a joint statement, while details are being settled, both Mullard and G.E.C. will continue to market separately their respective existing ranges of semiconductors.

Brown Brothers Ltd., the radio and electrical wholesalers, now in their 73rd year, have completed the final stage of a rebuilding and development programme at their London headquarters at Great Eastern Street. A new four-storey building replaces the former single-storey structure and total floor area has been increased to 215,000 sq ft.

Western Electric Company Inc., of New York, a manufacturing subsidiary of Bell Telephone System, has commenced an action in the High Court of Justice against Pye Ltd., claiming an injunction to restrain infringement of two Western Electric Patents 694,021 and 700,231, damages and ancillary relief. The claim arises from the manufacture and sale by Pye of broadcast radio receivers employing transistor circuitry. Western Electric said that it understands that Pye considers such manufacture and sale to be covered by an existing transistor licence.

Channel Television, programme contractor to the Independent Television Authority for the Channel Islands, announce that the camera and principal equipment suppliers for their studios at Rouge Bouillon, St. Helier, Jersey, will be E.M.I. Electronics Ltd. Test and supervisory equipment will be supplied by Marconi. The new I.T.A. station, at Fremont, Jersey, which is scheduled to open on September 1st next, will operate on channel 9 with horizontal polarization.

R.T.R.A. Set Proposed.—The Radio and Television Retailers' Association has been investigating the possibility of having its own branded television receiver for availability to members in a bulk buying operation.

OVERSEAS TRADE

Television Aids Leeds Buses.—Three small closed-circuit TV cameras, built and installed by Pye T.V.T. of Cambridge, are located at bus stops at City Square, Briggate and Corn Exchange in Leeds. The cameras, mounted on 22ft poles, are linked by underground cable to the control room at the Corporation's transport headquarters. Here traffic officers can manipulate the cameras by remote control to view traffic conditions and see how many people are queueing at each stop. Buses are then directed accordingly.

Advance Components Ltd. have reorganized their former Mains Stabilization and Instrument Divisions so that they are now virtually autonomous, linked by a strengthened central administration giving common services to both. They have been renamed the Volstat Division and the Instrument Division. A number of staff promotions have followed this reorganization and these include that of R. J. Dunnaway to be an executive director of the company and P. Sidey becomes general sales manager.

Telemax-Southern Ltd. is the name of a new company, formed jointly by Southern Instruments Ltd. and Telemechanics Ltd., to undertake the marketing of a new wide-range frequency meter and synthesizer designed by Telemechanics and manufactured by Southern Instruments. Headquarters of Telemax-Southern are at the Camberley, Surrey, factory of Southern Instruments.

Sigrist Distribution.—Southern Analytical Ltd., of Camberley, Surrey, have relinquished their sole U.K. agency for Sigrist Photometer AG. of Switzerland, but will continue to supply spares and service for all existing Sigrist installations and are to remain active in the field of continuous flow turbidity measurements.

Visual Electronics Corporation, U.S. representatives for English Electric Valve Company television camera tubes, have installed a complete EEV factory test set at their headquarters at 356 West 40th Street, New York, to facilitate their 24-hour adjustment service on image orthicon tubes.

E.M.I. Tape Ltd. is the new title of E.M.I. Sales & Service Ltd. the Emitape Division of which is now trading under the new name, and all orders and communications should now be addressed to E.M.I. Tape Ltd. at Blyth Road, Hayes, Middx.

Mullard Equipment Ltd. advise that their service department has been moved from Aboyne Road, Wimbledon, to the company's new plant at Manor Royal, Crawley New Town, Sussex. (Tel.: Crawley 28787.)

Dynamics Corporation of America has formed a British subsidiary, Digital Measurements Ltd., with 12,500 sq ft plant and engineering laboratories at Mytchett, Surrey, to design and produce factory automation and data processing equipment.

Jason Electronic Designs Ltd., of Kimberley Gardens, Harringay, London, N.4, is now in the hands of a receiver and manager, L. H. Cohen, of Newman Harris, Harcourt House, 19 Cavendish Square, London, W.1.

The Ministry of Aviation has placed an order valued at about £75,000 with Ultra subsidiary, W.S. Electronics Ltd., for a new u.h.f. airborne standby transmitter-receiver, which provides aircraft with air/ground communications even in extreme emergency such as a complete failure of the electrical power supply.

Solartron Servicing Courses.—A series of instructional courses has been started by Solartron to impart the latest know-how to the service technicians from their overseas companies and agents.

Oslo Television Centre's largest studio is being completely re-equipped with E.M.I. 4½in image orthicon camera channels and associated equipment. As a part of Stage I of the Norwegian transmitter programme, E.M.I. Electronics have also recently supplied the Norwegian Post and Telegraphs Department with a combining unit and radio frequency measuring equipment for the new Brown Boveri TV transmitter at Jonsknuten, near Kongsberg. Orders have been placed with E.M.I. under Stage II to supply similar equipment for the new TV transmitters at Vassfjellet, near Trondheim, and at Nordhøe, near Hamar.

Sound system for the new Hilton Hotel, Trinidad, is being provided by Trix Electronics Ltd., the Tottenham Court Road, W.1, subsidiary of Ultra Electronics Ltd. Nearly 300 bedrooms will be provided with a 3-programme sound radio relay, and the contract also covers supply of a paging system, ballroom and banqueting sound reinforcement, kitchen calling equipment and car parking control.

France is to have a civil ground secondary surveillance radar system installed at its Northern Air Traffic Control Centre, adjacent to the Paris airport of Orly. The equipment, consisting of an interrogator-responder and an aerial system, is to be supplied by Cossor Radar & Electronics.

Solartron's Mobile Demonstration Unit is at present undertaking a 3-month sales tour as part of the company's export sales drive. Itinerary covers Sweden, Denmark, Holland, France and Germany, with return to the U.K. on March 31st. The demonstrator carries a full range of data logging and tape recording equipment, an analogue computer and instruments.

The Royal Netherlands Navy has placed a large order with Marconi's Maritime Division for 1-kW broadband linear radio-frequency amplifiers, and have also awarded a contract valued at £200,000 to Racal Electronics for the supply of h.f. radio communication equipment.

Switzerland's Minister of Defence has signed a contract, valued at some £25M, for Bristol/Ferranti Bloodhound Mark 2 surface-to-air guided weapons. Bloodhound is the product of a consortium of British companies including Bristol Aircraft, Ferranti, A.E.I. and Bristol Siddeley Engines.

Twenty-four 6ft diameter paraboloids for microwave pulsed data transmission use, part of a data recording and telemetry system for a British Petroleum installation in the Persian Gulf, were dispatched recently by the suppliers, Applied Electronics Department of Ferranti Ltd., Edinburgh.

Athens Airport is to equip its main runway with a Pye Instrument Landing System. This brings the number of airfields so equipped by Pye to nearly 140.

All tankers in the Niarchos Group fleet are to be dual-radar equipped. An order for 36 Kelvin Hughes radar equipments for installation in the Group's vessels has been received by the Kelvin Hughes Division of S. Smith & Sons (England) Ltd.

The University of Ghana, in order to communicate with an expedition in Greenland, has erected a 42ft high wireless mast built in Dexion Slotted Angle.

Radio equipment for two s.h.f. radio relay systems for the Australian Post Office, one between Sydney and Orange and the other between Brisbane and Mount Matheson, is to be provided by the General Electric Co. Ltd.

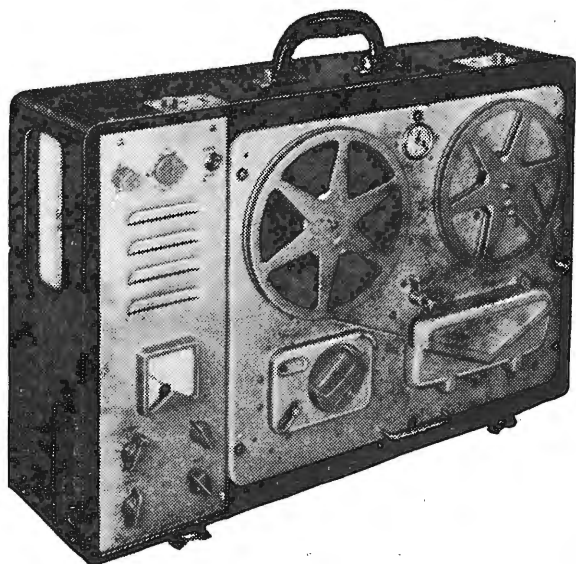

Vortexion quality equipment

The W.V.B. recorder has an additional amplifier and head with provision for "before" and "after" record monitoring while the recording is in progress, and this also has echo facilities.

The W.V.A. recorder has provision for a plug in stereo head and can be supplied with this and stereo playback pre-amplifiers with equalisation each having an output of 1 volt from a cathode follower. This is type W.V.A./S.

A heavy mumetal shielded microphone transformer is built in for 15-30 ohms balanced and screened line, and requires only 7 micro-volts approximately to fully load. This is equivalent to 20ft. from a ribbon microphone and the cable may be extended to 440 yds. without appreciable loss.

The 0.5 megohm input is fully loaded by 18 millivolts and is suitable for crystal P.U.'s, microphone or radio inputs.

The playback amplifier may be used as a micro-

phone or gramophone amplifier separately or whilst recording is being made.

The meter fitted for reading signal level will also read bias voltage to enable a level response to be obtained under all circumstances. A control is provided for bias adjustment to compensate low mains or ageing valves.

The power output is 4 watts heavily damped by negative feedback and an oval internal speaker is built in for monitoring purposes.

THE VORTEXION W.V.B. or W.V.A/S

are eminently suitable for making a high quality recording almost indistinguishable from the original since these models have facilities for monitoring the recording actually put on the tape with only a fraction of a second delay.

By this means, when for any reason the signal is distorted or not as required, the result of the recording on the tape can be heard almost instantly, and adjustments can be made until the results are as required.

Many types of music today have the treble boosted considerably, and may result in greater power being recorded at high frequencies than at

middle frequencies, an overload of the tape at high frequencies gives a mushy quality with lots of hiss and background noise.

Adjustment to the bias level while listening to the result is useful in this connection especially where the brand of tape and the bias setting for it are not exactly known.

Again if clean treble recordings at $3\frac{3}{4}$ in. are of prime importance it is now recognised that no other method is quite so effective in achieving this as reducing the bias slightly while listening to the results. The meter reading of the new bias setting for the particular tape used may be noted for future use.

VORTEXION LIMITED, 257-263 The Broadway, Wimbledon, London, S.W.19

Telephones: LIBerty 2814 and 6242-3.

Telegrams: "Vortexion, Wimbledon, Lon."

ACOS ADVANCE | styli

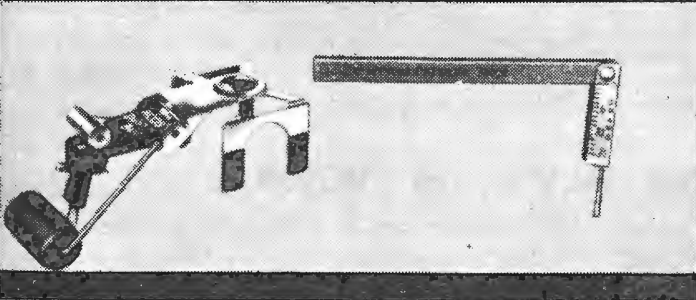
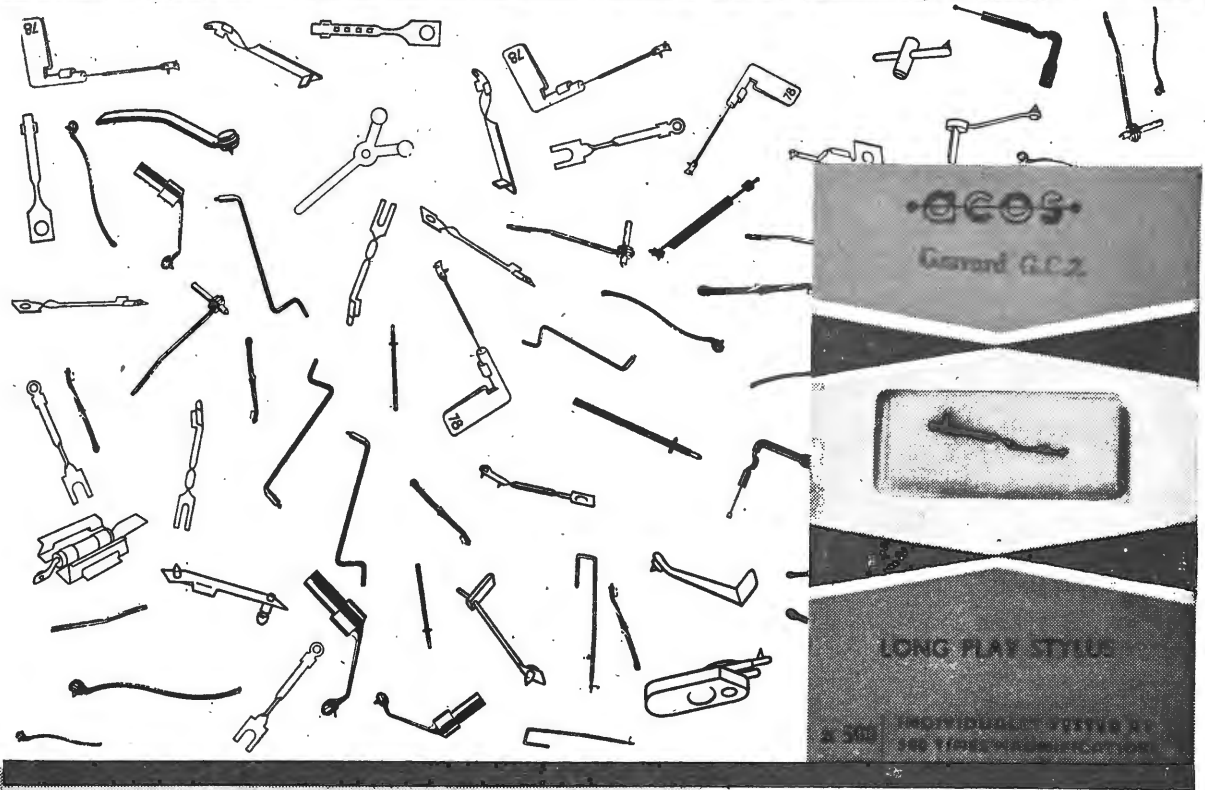

 & changer dust bug
& stylus pressure
gauge

Acos continue to advance and be recognised. Recognised as the finest range of replacement styli now available. Diamond and sapphire, mono and stereo, there are now over 150 types of Acos x500 styli, to fit all makes of pick-ups and cartridges. There is one to fit *your* equipment. All Acos x500 styli are individually tested at 500-times magnification, yet they cost no more than other makes. Look for Acos styli in the characteristic pack. *Accessories after the fact:* Don't overlook the Acos Changer Dust Bug that sweeps all before it, and the Acos Stylus Pressure Gauge which stops pick-ups from throwing their weight about.

Other Acos products: mono and stereo pick-ups, cartridges, microphones.

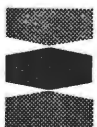

ARE DOING THINGS IN STYLI

COSMOCORD LTD, WALTHAM CROSS, HERTS. TEL: WALTHAM CROSS 27331



Physical Society Exhibition

NEW DEVELOPMENTS IN ELECTRONICS

The "Physical Society" Exhibition can be relied upon to provide a very pleasant break from the multitude of "selling" shows. Examples of the uses of electronics in industry proliferate, and the ingenuity and simplicity of some of the proposed systems are much to be admired.

Throughout the week the exhibition was attended to the point of overflowing, and one dares to hope that it will eventually be removed to some Olympic hall.

Satellite motors for attitude control are required to produce thrusts of only a few dynes, and it is feasible to employ ionic beams. Elliott Brothers (London) Ltd. have developed and were demonstrating a motor of this type giving a thrust of about 25 dynes. Argon is "leaked" into a gun structure surrounded by a magnet solenoid. The argon is ionized under the influence of electrons emitted by a filament and constrained by the magnetic field, the resulting ions being accelerated towards the exit of the gun by a high voltage (5kV).

Naturally this production and emission of ions would result in the development of unwanted potentials in the gun, so it would, in practice, be necessary to neutralize the beam. This can be achieved by emitting electrons from a filament in the path of the accelerated beam.

The demonstration apparatus was working, with the aid of an oil-diffusion pump, at a pressure equivalent to a height of about 150km. Efficiency (energy out/energy in) was 35% but could be raised by the use of "heavier" ions—mercury would be very suitable—but argon or a similar material had to be used to avoid fouling of the pump.

Electrolytic tank simulation is of course by no means a new technique for solving problems, but a particularly sophisticated example shown by the United Kingdom Atomic Energy Authority involved obtaining velocity as well as the normal position information, the automatic summation of different solutions, and moving electrodes. This simulator was designed to study the bubbling of gas pumped through a bed of fine solid particles, a process which has many applica-

tions in chemical engineering. Four closely-spaced probes are actually provided so as to measure the potential gradients in the X and Y directions. These gradients are used to control the speed of velodyne motors which then drive the probe and recording pen along the direction of the maximum potential gradient at a speed proportional to this gradient. This simulates both the path and velocity of current flow. Current

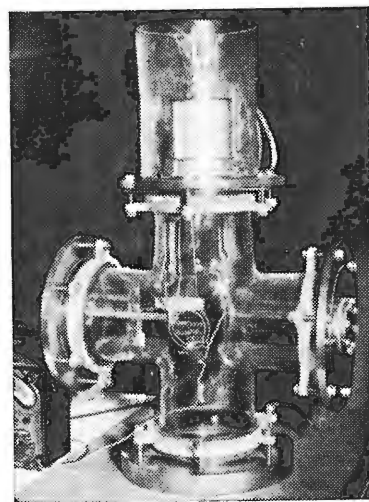

Experimental ionic rocket motor developed in high-voltage division of Elliott.

flow about a conducting electrode simulates gas flow about a stationary bubble, and current flow about an insulating electrode simulates solid particle flow about a moving bubble. By making the electrode bubble analogue out of a number of fine wires around an insulator, these conditions of conductor or insulator could be simulated by electrically connecting or separating the wires respectively. By switching between these two conditions and summing the two sets of probe outputs so obtained in various proportions (depending on the relative gas and bubble velocities) streamlines or plots of the flow of elements of gas relative to a moving bubble can be obtained. Pathlines, or plots of elements of gas relative to fixed coordinates, can be obtained by moving the bubble electrode analogue at a fixed velocity corresponding to the bubble velocity and adding the same velocity to the recording pen as it attempts to trace streamlines. Streaklines, or lines formed by tracer material suddenly injected at a fixed point, can be obtained by using the pen velocity information to join up points corresponding to the same time on diverging pathlines.

Arc discharges are used in optical instruments because of their small source and high brightness, but the instability of the arc necessitates frequent readjustments. Bendix-Ericsson were showing a simple servo-system for the production of a stationary image from a wandering arc. A beam-splitter mirror in the light path feeds the point image on to a group of four phototransistors representing the four quadrants into which the arc may wander. The outputs from these are amplified and used to tilt, by energizing four miniature solenoids not unlike telephone-carriage coils, a focusing mirror in the light path.

Voltage discriminator using a modification of the Schmidt-trigger stage to give a very sharp and well-defined triggering voltage level has been developed at the Cavendish Laboratory, Cambridge. The common cathode resistor of the Schmidt stage is split into two separate resistors and the two cathodes are joined by a diode. As long as the diode is cut off the first valve acts as a cathode follower but when the potential rises sufficiently to cut on the diode, the circuit reverts to the Schmidt state. The trigger point is thus set only by the diode going into conduction,

which is not affected by supply variations.

Vibration amplitude of an oscillating quartz crystal varies linearly with applied gaseous pressure. In a device developed by the Brunel College of Technology this effect is employed in a vacuum gauge for measurements in the range 0.1 torr—25 torr. The crystal is connected in a transistor Colpitts oscillator circuit, coupling being adjusted to the minimum. The output of the transistor is rectified and fed to a meter which can then be calibrated directly in pressure.

Positive feedback usually reduces the bandpass of a device, but in the case of a hot-wire anemometer developed by M. J. Somerville and G. F. Turnbull of the University of Manchester and shown on the N.R.D.C. stand positive feedback raises the upper frequency limit, albeit indirectly. The hot platinum wire, only 10^{-4} in diameter, if connected in a bridge circuit and energized by d.c. would give a bandwidth of about 200c/s, i.e. it would respond to variations in airflow of up to 200/sec. However, in Somerville and Turnbull's circuit the hot wire forms part of a potentiometer across a centre-tapped output transformer of an amplifier and the feedback is taken from the potentiometer, which is arranged to be positive with the hot-wire at its working temperature. As the airflow cools the wire the amplitude of oscillation increases, so maintaining constant the temperature of the wire. The circuit oscillates at about 200kc/s, the amplitude of the r.f. being equivalent to wind speed. The r.f. is thus rectified, when the d.c. or mean level corresponds to the average air speed and the impressed rapid variations represent the tur-

bulence. The gain in bandwidth depends on the amplifier gain, but a multiplication of 100 times is said to be achieved.

Impedance transformer using ceramic elements has been made by H. S. Wolff, of the Medical Research Council, and was shown on the N.R.D.C. stand. Providing an input impedance that is mainly capacitive—the leakage is about $10^{10}\Omega$ —the device consists of a pair of piezo-electric bimorphs carrying, at their free ends, a minute ferrite pot core containing a coil and the ferrite disc that completes the magnetic circuit. When a potential is applied to the bimorphs they bend by a few microns for each volt impressed so altering the reluctance of the magnetic circuit. The corresponding change of inductance can be used to vary the frequency of an oscillator whose output is amplified and converted back to d.c. by a Foster-Seeley circuit: obviously this can be followed by a d.c. amplifier giving practically any desired output impedance. If a closed-loop technique is adopted, i.e. the output is fed back to the piezo-electric bimorphs, the input resistance can be raised by the gain of the amplifier and the effective capacitance reduced. The model shown achieved an input resistance of about $10^{12}\Omega$.

Electronic "spirit" level, shown by G. V. Planer Ltd., can detect variations from level of at least 1 second of arc and has a long-term stability of 10 seconds of arc. In the level tube are three electrodes which sense the position of the bubble in the electrolyte. Variations of electrolyte resistance change the conditions in an associated bridge circuit and the bridge signal is amplified for display on a meter.

INDUSTRIAL ELECTRONICS

Vibration measurement.—To avoid the somewhat messy business of arranging strain gauges and slip rings with their attendant cooling problems, Bristol Siddeley Engines have developed an f.m. system of jet-engine turbine-blade vibration measurement. Wire bent into the form of a "square zig zag" is placed round the periphery of the turbine and a small magnet mounted in the blade tip induces a roughly sinusoidal signal across the ends of the

wire. Two components are present, the "carrier frequency" which is proportional to the mean speed of the turbine and an f.m. component which is proportional to the speed variations caused by vibration. The signal is limited to remove amplitude fluctuations and unidirectional pulses are developed, the average voltage of which is proportional to frequency. The mean frequency is filtered out to be indicated on a meter, leaving the modulation due to

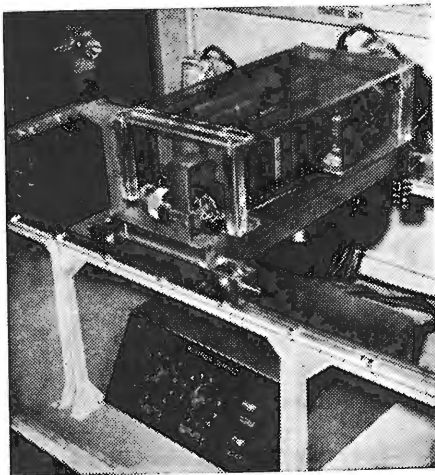

B.I.S.R.A. experimental digital crane-position control system. Infra-red transmitters can be seen at left.

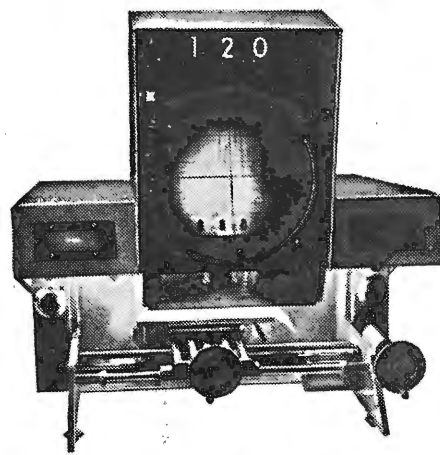

Graph analysis equipment by "Shell" Research. Digital read-out indicates the co-ordinate value.

vibration, which is fed to a tape recorder. Multiple wires or grids, which incidentally are not wires at all but sheet copper stamped to shape, enable the complex blade tip movements to be completely determined.

Magnetic tape recording principles are used to advantage in equipment developed by Baldwin Industrial Controls for the measurement of the length of steel strip from a rolling mill. After erasure of the magnetism set up in the strip by the electrolytic cleaning process, the strip passes under a print coil and a pickup coil which are exactly one foot apart, or a similar unit distance. A manually produced pulse is recorded on the strip and reproduced by the pickup coil as the strip passes under it. The reproduced pulse is also used to record the next pulse automatically so that the reproduced pulse occurs as each foot of strip passes under the pickup coil, irrespective of the strip speed. The pulses are now fed to a counter and displayed. As the amplitude of the pulses varies with strip speed the input stage of the counter is a variable- μ pentode whose suppressor voltage is derived from a tachogenerator driven by the mill so that the output pulse remains constant.

Analysis of photographs of c.r.t. traces is a time-consuming and tedious task; but this is a task where a slow-scan television technique can be used to carry out measurements automatically. Cawkell's "Editor" film reader employs a flying-spot scanner to illuminate the film. Gate

circuits are set up to open just before the trace base line and close after the top of the waveform: the scan crossing the base line starts a counter registering the number of cycles executed by a standard oscillator until the top of the waveform is reached. The completed apparatus will handle four traces at a time and give measurements accurate to within 1%. 100 measurements can be made in 40sec; measurements that can, if necessary, be fed directly into a computer.

An analyser similar in principle was shown by the U.K.A.E.A. (developed at the Atomic Weapons Research Establishment) but the intention of this apparatus is the analysis of the shape of waveforms. A 156-line scan is used, taking $250\mu\text{sec}/\text{line}$ and the scanner output is converted to digital form for printing-out on punched paper tape.

For the conversion of graphs into digital form "Shell" Research have introduced their equipment for the analysis of opaque charts up to 12cm wide. The section to be analysed is illuminated and projected on to a viewing screen. The image of each point to be digitized is brought into coincidence with cross lines on the screen by means of x and y lead screws. These are linked to the sliding contact of two potentiometers which then carry voltages proportional to the co-ordinates of the point under examination. A digital voltmeter then displays the x and y co-ordinates depending on the setting of a front-panel switch.

Digital position control for cranes and similar conveyor devices was

demonstrated by a model on the British Iron and Steel Research Association's stand. Position demands set in (coded in feet and inches for demonstration) are converted to serial digital code and turned into infra-red pulses from lamps directed at the travelling trolley. The trolley is prepared for the reception of a new demand by switching on both transmitters (lamps), which stops the motor. The pulse trains are then transmitted to the crane, where they pass into a demand register: this is the signal for the motor to start again. The system works by adding or subtracting the new information from that already standing on the demand register, which is compared with the position register that "ticks up" the position of the crane. So that slip cannot affect the result the position register is "checked" at several fixed points along the trolley traverse. Standard solid-state logic-element "bricks" are used throughout (Mullard Combi-Elements).

Digital shaft encoder checking by normal methods, wherein the shaft is slowly rotated and each output monitored, are extremely wearisome and uneconomic. As the vast majority use a cyclic code, wherein only one output changes for each digit change, a simple form of logic can be employed. By definition, the number of lines indicating either state is alternately odd or even. If then the outputs are connected to multiple input "AND" gates, the output of the gate will be a perfect square wave for a good encoder. A convenient way of using the infor-

mation is to display it on a storage oscilloscope. The encoder is divided into five sectors, each being displayed on ten displaced lines of the oscilloscope. The relevant section is triggered by a photo-electric sensing device.

An application for a digital pulse generator was exhibited by the United Kingdom Atomic Energy Authority, in which the velocity of sound through a sample of material was investigated by means of the pulse generator and an oscilloscope. The procedure is to fire a pulse from the pulse generator through the sample of material. A second pulse derived from the pulse generator is adjusted to coincide with the arrival of the first pulse, and the detected coincidence is indicated on the oscilloscope. The setting of the pulse generator controls, and a precision variable delay line, which is fitted with a digital indicator, gives the time delay. The pulse interval generator is digital in operation and so the time delay can be shown to a fraction of a millimicrosecond, in a total time of up to 100 microseconds. The velocity of sound is therefore known extremely accurately.

Stability of rotational speed of a driving shaft is measured and displayed to within one part in 10^4 of 1 r.p.s. by an equipment shown by Mullard, in which a standard frequency is compared with that derived from the output end of the system. A glass disc marked with one hundred fine radial lines is mounted on the shaft and moves in an optical system, thereby causing pulses to be developed on the collector of the photo-multiplier. The measurement is effected by triggering an oscilloscope time base with the standard frequency pulse and z-modulating the trace by means of the output pulse. The time difference between the standard and output pulses is now represented by the distance between the start of the trace and the bright-up spot. The process is repeated for each of the hundred pulses, successive sweeps being displaced vertically in the form of a raster. Instability of rotational speed is indicated by the spot wandering from side to side.

A ferret would seem to be an unusual exhibit at the "Phys. Soc." But "ferret" is the name applied to a device passed through pipes, motive power being supplied by pressure from a fluid behind it. Water undertakings clean out their mains by pas-

sing a brush-and-scraper ferret through the pipes. Unfortunately the tools sometimes get stuck and necessitate the digging up of considerable lengths of main, so a device that will indicate the position of the ferret to an observer on the surface is of great value. The Water Research Association have developed such a system: attached to the scraper is a watertight enclosure containing a solenoid energized by a 30-c/s transistor oscillator for a brief period each second. Although the iron pipe shunts much of the resul-

tant field, sufficient escapes for it to be detected several feet away by a portable apparatus. The pickup in the detector is another solenoid having an inductance of several hundred henrys; the signal output from this is amplified and used to "gate" a 1-kc/s signal that feeds headphones, so that the operator can follow the ferret as it runs along the pipe. It is hoped that it will prove possible to add some form of leak detector to the ferret—this could help to reduce the present wastage of more than 10% of the nation's water supplies.

COMPUTING

Desk calculator shown by the Physics Department of Kings College, Durham University, used relatively simple circuits built round p-n-p and n-p-n transistors, bi-directional Dekatron counters and cold-cathode trigger tubes. A feature of this device is that only very few switches are needed, since the trigger tubes (which set up numbers and instructions into the Dekatron accumulator) are activated simply by touching a finger across two electrodes so as to bleed in a small extra current (200 μ A) to the tube (they are already biased nearly on).

Analogue multiplier/divider shown by Texas consists of a pulse generator triggering a chopper modulator: one input is fed to the pulse generator to proportionately vary its p.r.f., and the second is fed to the modulator. One input thus modulates the other, and it can be shown that if the modulated output is integrated, an output is obtained, which, depending on the polarity of the chopper drive waveform, is proportional either to the product or ratio of the two inputs.

Analogue storage systems which do not require the continuous expenditure of power are being investigated by the Medical Research Council. The nearest equivalent to such a device which is presently available would appear to be a motor-driven potentiometer, but it would be difficult to make such a device small and cheap enough for use in quantity. In an exhibit shown by the Council, the information is stored as the opacity of a thin metal film which can be reversibly electrolytically plated and unplated on to a transparent conducting base, the plating charge

(current \times time) being determined by the analogue quantity being stored. Another possible system would be to store the information as the degree of magnetization of a hard magnetic material.

Film storage developments shown by Plessey related to the use of low-temperature superconducting films to store information as the directions of rotation of a number of continuously circulating currents. These currents must be stabilized, and rather than do this by cutting a hole in each storage element round which current can circulate, Plessey propose simply to use the non-superconducting (resistive) region generated inside each circulating current by the action of its magnetic field on the film.

G. V. Planer showed an 8×8 store using separate cylindrical magnetic film elements electroplated on to non-magnetic tubes.

Dynamic diode-capacitor store shown by A.E.I. reverses the normal procedure of using switching elements to store the information (in the form of whether they are conducting or not) and capacitors to couple between stages, by storing the information in capacitors (as charge or no charge) which are connected (as shown) by a chain of p-n-p-n switching diodes. The information is applied as a positive pulse to the first capacitor (C_1). This information is then moved by applying a positive transfer pulse to the same capacitor so that the resultant voltage across it exceeds the strike voltage of the p-n-p-n diode SD_1 . This diode then transfers the charge from the first capacitor to the second (C_2). A similar pulse then transfers this charge to the third capacitor and so on; the

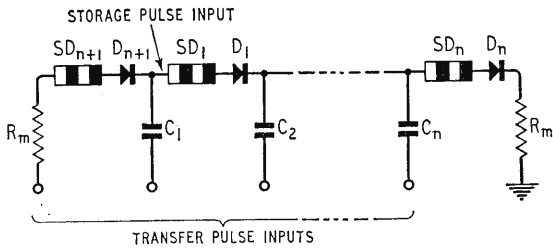

A.E.I. dynamic diode-capacitor store.

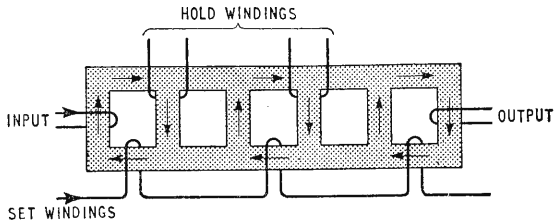

Laddic multi-aperture device shown by Mullard.

charge travelling down the chain (from left to right). If the end p-n-p-n diode (SD_n) is terminated in a resistor R_m , this forms a mismatch to the discharge of the last capacitor so that this capacitor acquires a negative charge. This negative charge then travels back down the chain in the reverse direction (from right to left). If when it reaches the first capacitor, a trigger pulse is applied to the p-n-p-n diode SD_{n+1} through a similar mismatching resistor, the first capacitor charges positively through this mismatch resistor. This positive charge then travels down the chain as before (from left to right). The information thus remains continuously circulating in the line. The ordinary diodes shown ($D_1 \dots D_{n+1}$) prevent the transfer pulses from causing Zener breakdown in the p-n-p-n diodes to their left rather than as intended, from striking over the p-n-p-n diodes to their right.

Character recognition system shown by the British Iron and Steel Research Association follows the character's curve in a series of equal-length steps, making a circular scan at each point to determine the direction of the next step. (Special rules are necessary to cater for crossovers, cusps and breaks in the character.) This describes the character in s, ψ co-ordinates, where s is the distance along it and ψ the angle between an elementary step length and a reference axis. If the step length is made proportional to the overall character size (which could be determined by an initial scan) the sequence of changes of

direction of successive steps will be similar for different forms of the same character and be independent of its orientation and size. An unknown character can then be recognized by normalizing its measured ψ values to eliminate relative rotation, and summing the squares of their differences from the corresponding various standard ψ values: the standard giving the smallest summed squared difference being the unknown character. Initial work has shown that, in the case of the numerals, even roughly scrawled figures can be correctly identified by this system, although some ambiguity arises from badly drawn 6's, 9's and 0's.

"Laddic" multi-aperture devices were shown by Mullard. Multi-aperture devices consist in general of a square-loop ferrite core with a number of holes in it (threaded by coils). Their action depends on the fact that the switching in the volume round an individual hole depends both on the locally-generated flux and on the flux in the core as a whole. This logically interconnects switching currents in the coils providing these fluxes, and this interconnection can be used to build up computer circuits. Such circuits, although possibly slower and requiring more drive power than more conventional transistor circuits, are more reliable, simpler, smaller and lighter. In a laddic the square-loop material is in the form of a ladder with an even number of rungs (see diagram): a set wire interlinks odd-numbered side rails of the ladder, and input, output and hold coils the

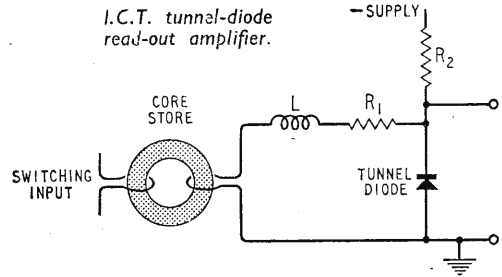

end and even-numbered intermediate rungs respectively. A saturating pulse is applied to the set wire (producing, for example, flux in the directions shown) followed by an input pulse producing flux in the opposite direction in the first rung: the hold windings produce flux in the same direction as the set winding in the even rungs. It can be seen that the input current will reverse the flux through the first even rung whose hold winding is not energized. Thus an output is only produced if all the hold windings are energized. This provides an AND function. An OR function may be obtained by winding several hold windings on each rung, since any one will be sufficient to hold the rung. A fail-safe facility is provided by the fact that any failure prevents an output from being produced.

Tunnel diode fast computer circuits were shown by I.C.T., Plessey and Elliott. The Elliott circuits were built round the Majoritron or Goto pair. This consists of a matched pair of oppositely biased series-connected tunnel diodes, and acts like a flip-flop. Since this is only a two-terminal device, a three-phase drive input is necessary to fix the direction of signal transfer when a number of Goto pairs are connected in cascade. Plessey used hybrid circuits of tunnel diodes and transistors.

I.C.T. showed a simple read-out amplifier and low-level discriminator (see diagram). The output from the core store is integrated by the inductor L and applied to switch the tunnel diode. The inductance can provide both the required high impedance for the tunnel diode and low impedance for the core, since the core switching frequency is much less than that of the diode. The triggering level can be adjusted by varying the standing bias to the tunnel diode set by R_1 and R_2 . Since this diode is fed with the integrated output from the inductance, this circuit is little affected by transients in the switching circuit.

Rapid carry counter shown by Plessey consists of a series of saturating transistor gates triggered by the individual binary counters. Just before a carry pulse has to be propagated the series of binary counters

which then show 1 open the corresponding series of gates so that the carry pulse is propagated straight through the gates rather than at a much slower speed via the individual counters.

TEST AND MEASUREMENT

Signal generator. There was a remarkable dearth of new signal and pulse generators, most of those observed being used as parts of exhibits. However, an interesting new instrument is the Dawe Type 423 six-decade oscillator. This instrument, which uses transistors, covers the range 2c/s to 2Mc/s, and can also be used as an analogue frequency meter over this range. The normal calibrated frequency control is conspicuous by its ab-

sence; frequency is indicated by meter. Improved amplitude stability is achieved by the use of a modified Wien bridge to determine frequency, in which the normal two-gang frequency control is replaced by a single variable resistor. At the lowest frequency end of each decade the accuracy of the frequency meter is improved by the use of a times-three sensitivity multiplier.

which uses transistors throughout, is capable of operation up to 100Mc/s, which, of course, eliminates any necessity for frequency converters up to this frequency. The 100Mc/s feed-forward decade uses the 2N769 transistor. The number of counters capable of 10 Mc/s operation has increased enormously since last year, and a typical example of this type of instrument is the Langham Thompson 6010/8, which is notable for its

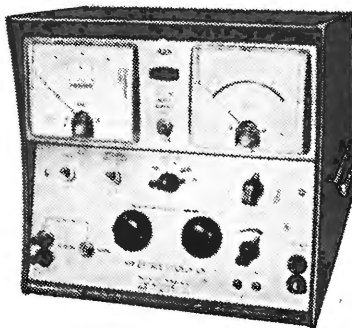
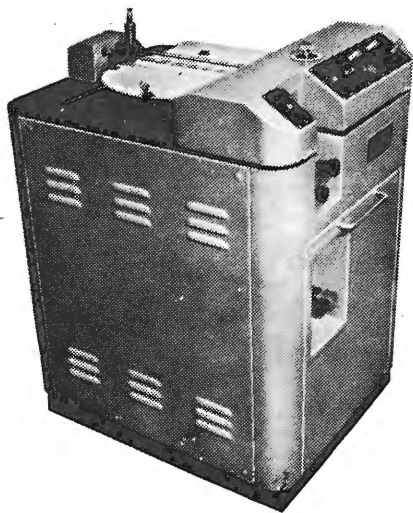

Above: Six-decade oscillator shown by Dawe. Left-hand indicator is frequency meter.

Left: Automatic aerial radiation-pattern recorder seen on the Barr and Stroud stand.

pleasing mechanical design. A push-button function selector is employed, which automatically positions the decimal point, and edgewise controls are used for display-time and cycling time adjustment. To extend the frequency range below the normal limit of 20c/s a small plug-in trigger unit is available which converts low frequencies to pulses.

Frequency measurement is now almost entirely the province of digital frequency-meters or counters, which offer extreme accuracy and simplicity of operation. An advanced instrument of this type is the high speed counter which Venner Electronics have under development. The first decade of this instrument,

which then show 1 open the corresponding series of gates so that the carry pulse is propagated straight through the gates rather than at a much slower speed via the individual counters.

A sensitive wide-band oscilloscope using transistors was exhibited by the University College of North Wales. Two transistor current amplifiers are used with a series impedance in the sensing probe to provide constant current input. Sensitivity is 100mV/cm and the upper cut-off frequency is 100Mc/s. The probe output is coupled by a 100Ω

cable to the amplifier, which itself has an input impedance of 100 ohms. Two stages of amplification are used, the current gain of the first one being 20 and the transfer impedance of the second being 5,000 ohms. The output of the second is in the form of symmetrical output voltages for the y-plates. The time-base for the oscilloscope is derived from a capacitor which is in the collectors of two complementary transistors. Step functions are applied to both the emitters of the transistors which then supply a constant current into both plates of the capacitor. The resulting wave form is a symmetrical 60V ramp of 30nsec duration which is applied symmetrically to the x-plates. The step functions applied to the transistor emitters are generated by avalanche transistor stages.

An oscilloscope shown by the U.K.A.E.A. is a high speed low sensitivity instrument with a y-sensitivity of 1 kV/cm and a 20kV magnetically focused tube. No valves or transistors are used and a spark-gap CR discharge circuit is used for the time base. Signal delay is by 15 metres of helical-membrane coaxial cable, and the y-deflection is effected by two wires running through the c.r.t., forming a balanced 200Ω line.

Resistance-tolerance testing in the large-scale production of resistors is facilitated by the Cambridge Instrument Deviometer which consists of a resistance bridge, supplied from a thousand cycle oscillator via an amplifier. The component under test is compared in the bridge with a standard value resistor; any unbalance voltage is amplified by a very stable amplifier, detected by a phase-sensitive rectifier and indicated on a moving coil meter which is calibrated in percentage deviation. The output of the power amplifier is fed to a number of pre-set tapping points which can be selected to give a tolerance range of between ±1% to ±50%. Gross unbalance in the bridge causes no damage as the output circuit limits at 150% full scale deflection.

With a maximum reading of 200,000,000 MΩ the Pye Wide Range Megohmmeter is suitable for the measurement of resistance in capacitors or cables. A 500V supply is obtained from a transistor converter and applied across the unknown resistance. The current passing through the resistance develops a voltage across a comparatively low-value reference resistor, this voltage being amplified by an extremely linear and gain stable d.c. feedback

amplifier, which uses one electrometer valve and two transistors. To prevent error when measuring the leakage resistance of capacitors or cables, a device is incorporated which ensures that before the reading is taken all capacitance is charged.

Noise-level analysis: Designed to assess the amount of annoyance caused by a given sound, the Dawe Statistical Analyser records the number of times a signal exceeds pre-set levels. Either rectified a.c. or slowly varying d.c. may be applied to the instrument. The signal applied is fed to a sampling circuit where samples are extracted at an adjustable rate, the total number of samples taken being indicated on a counter. Each sample is fed to a coincidence gate, the other input of which is one of three pre-selected levels. If any one of these levels is exceeded a pulse is applied to the associated pre-set counter.

Plotting of aerial radiation patterns on the traditional point by point basis is a long-drawn-out process; any method of reducing the tedium is obviously to be applauded, and accordingly Barr and Stroud have produced an automatic radiation pattern recorder. The square-wave modulated signal from a rotating microwave aerial is frequency-changed to give an intermediate frequency of 60Mc/s and passed via an amplifier to a piston attenuator. The output of the attenuator is handled by a servo amplifier which sets the attenuator automatically to give constant output. Linked to the servo controlled motor which drives the piston attenuator is a recording pen, which is therefore positioned to give a reading of received signal at the aerial. The plotting table rotates with the aerial giving a polar diagram and aerial response indicated in dB. A cartesian plot of aerial response may also be obtained.

can be re-reflected, only this light path can result in laser output.

Tunnel diode local oscillator L-band source was shown by Plessey. Since the available voltage swing depends on the diode material, the power output can only be raised by increasing the diode current, and this reduces the diode impedance. At the powers required for a local oscillator, this impedance becomes so low that loading problems and parasitic oscillations are likely. Plessey's solution of this difficulty is simply to connect the tunnel diodes and their biasing resistors in series.

Klystron signal generator range shown by Flann is unusual in that a single control suitably tunes both the klystron cavity and its reflector voltage. Rather than use a complicated mechanical ganging system between the cavity plunger and reflector voltage controls, the required non-linear relationship between the cavity plunger position and reflector voltage is obtained simply by placing a shunt across one arm of the reflector voltage supply potentiometer (in series with the wiper) and a resistor in series with each end of this potentiometer. The two end resistors are changed by microswitches on the main control when it becomes necessary to use another klystron voltage mode.

MICROWAVES

Pulsed lasers shown by the Royal Radar Establishment and the National Physical Laboratory built up stimulated light radiation by multiply reflecting it between the partially silvered ends of a cylinder of suitable solid material. (For a fuller account of this method see the Technical Notebook Section of our December 1960 issue.) One problem in this system is to pump sufficient light into the solid from the pulse discharge tube used, and at this exhibition several optical focusing methods were shown for doing this. At high pump powers the gain

may be sufficient to produce oscillation after only a few reflections in the material, and considerable output may be produced in unwanted directions by slightly non-axial reflections. A way of avoiding this effect shown by the N.P.L. is to use an un-silvered cylinder at one end of which is placed a fully reflecting mirror covered with a diaphragm with a small hole in it: at the other end of the cylinder a lens focuses a parallel beam of light from a partially-reflecting mirror on to the diaphragm hole. Since only light passing through this hole

Strip line components were shown by Cossor and Elliott. Such components have the advantages of being relatively broadband and compact (particularly when complicated), and when produced by printed-circuit photo-etching techniques offer the further advantages of high order of

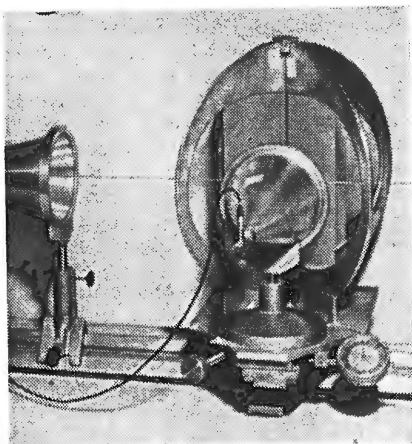

Mullard dielectric line standing-wave indicator.

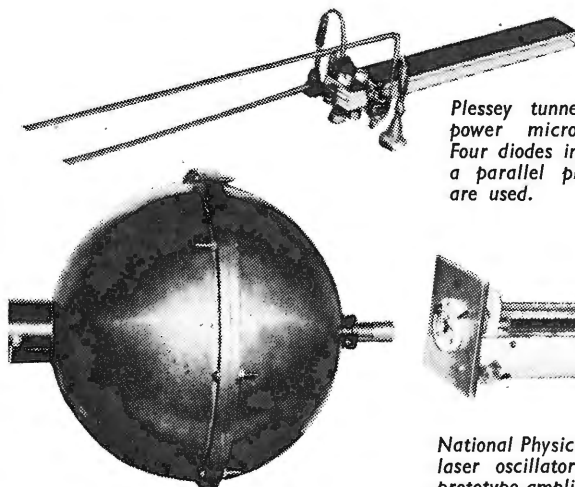

Plessey tunnel diode low-power microwave source. Four diodes in series across a parallel plate resonator are used.

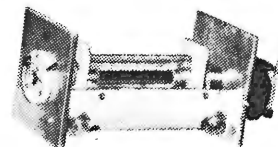

National Physical Laboratory laser oscillator (left) with prototype amplifier (right).

reproducibility in performance coupled with low weight and cost. The lines shown were in the "tripla-plate" form which has a central strip between two ground planes. An alternative is to etch a strip on one side of a clad laminate, but this unbalanced form of line suffers both from radiation and dielectric losses. The losses and effects due to non-uniformities in the dielectric which arise in triplate lines when the strip is supported in the centre of a solid dielectric can be almost eliminated by using an air-dielectric and making the central conductor in the form of two strips etched on opposite sides of a thin supporting septum, since then only fringing fields lie in this septum.

Dielectric line components shown by Mullard for the mm-wave region utilize the HE_{11} mode propagated near the surface of dielectric rod. Such components offer the advantage of being much larger than their conventional wave-guide counterparts. Examples shown were a probe-type standing-wave indicator and high-Q resonator. The latter consisted simply of two reflecting plates between which was stretched a dielectric line. By making the line out of a number of fibres it can be given an elongated cross-section. For a given field spread the cross-sectional area and thus the loss in the dielectric are then

less than with a circular cross-section, and this technique allows Q's of 90,000 to be achieved at 4mm. The standing-wave indicator consisted of a pair of crossed partially-reflecting flat "mirrors" made up of spaced dielectric threads: the dielectric line being at 45° to and threading each "mirror." The mirrors reflect equal portions of the powers travelling to and fro along the line; on summing these portions in a detector any standing waves are indicated.

Waveguide components shown by Sanders included ranges of direct-reading wavemeters, short matched loads and high-isolation (110dB) switches. In the switches, the high isolation is achieved simply by absorbing material on the rotor, rather than by resonant chokes. This method has the additional advantage that the isolated section sees a reasonably good match. The matched loads can be made about $\frac{1}{2}$ the normal length (for the same performance) by using two tapered absorbent wedges rather than the normal one. In the direct reading wavemeters the hyperbolic cavity piston movement is converted into the required linear drive movement by means of a wedge pivoted about a point on the projection of one of its sides: the drive bears on one side of the wedge and the cavity piston on the other.

germanium as well as a better peak-to-trough ratio. Top temperature for these is about 120°C —above this the indium contacts give trouble.

Photoconductive detectors for sub-millimetre radiation could be made with very pure indium antimonide: unfortunately indium antimonide of the required purity is not available. The application of a magnetic field of about 6,000 gauss and cooling to about 2°K can, however, reduce interaction between neighbouring impurities in the purest samples obtainable to the point where the photoconductive effects can be observed, not only at sub-millimetre wavelengths but in the 1-10mm region also. Response time is as short as $1\mu\text{sec}$.

In a detector shown by R.R.E. the sensitive element is held at liquid helium temperature, about 1.5°K . The use of a permanent magnet, though, has the disadvantage that the stored heat boils off a large amount of helium before stability is reached. Instead a solenoid of niobium wire (which superconducts at liquid helium temperature) is used, and a current, once started, continues indefinitely. Starting the current is, however, a difficulty, so, to provide a finite resistance "insulator" in the zero-resistance coil, a segment of the coil is subjected to a strong momentary magnetization from a "quench" coil to destroy the superconductive effect.

SEMICONDUCTORS

Gallium arsenide may well prove to be the semiconductor of the future: it can be prepared with a wide range of resistivities ranging from "normal" for a semiconductor up to at least $1\text{M}\Omega/\text{cm}$ which is a typical value for high-energy-gap materials such as cadmium sulphide. In this form gallium arsenide is referred to as "semi-insulating"; but unlike other "semi-insulators" it has a high carrier mobility and thus can be used not only for photo-resistors but also for transistors and other such devices. The Services Electronics Research Laboratory were showing some expected applications of gallium arsenide, such as a field-effect device oscillator running at 1kc/s , and some unexpected ones too. A property of a gallium arsenide "resistor" is, for instance, that it departs from ohmic behaviour and will oscillate if a field of more than about 200V/cm is applied. The frequency

is affected by illumination, so a very simple light-sensitive oscillator circuit is produced. Two most important properties are the substance's upper temperature limit, which is very much higher (possibly as high as 300 or 400°C) than silicon and the ease with which solid circuits can be made up. The insulating form can be used as the substrate, and can be doped and provided with epitaxial layers of gallium arsenide, gallium phosphide and germanium with comparative ease. The material is most useful for tunnel diodes too: S.E.R.L. point out that a very small junction area can be obtained by the use of both forms, without making the assembly too fragile to be practical. Experimental gallium arsenide tunnel diodes were shown by A.E.I. also: comparison of the curves obtained with those for germanium show a negative resistance region of about twice the extent of that for

Transistor and diode development has, in the main, been following paths already laid down; thus the news here is more of improvements than of new "breakthrough": typical examples were the widespread examples of solid circuits and mesa devices. The application of mesa techniques has given Texas, for example, the "micro-G" diode, which has a $40\text{-M}\Omega$ back resistance at 10V and is only about 0.06-in long by about 0.04-in in diameter. G.E.C. were showing some fruits of their "technical co-operation" with G.E. (U.S.A.) in three fast-switching mesa transistors Types 2N705, 2N710 and 2N7110. High frequencies are not the sole province of the mesa type (Texas 2S131 epitaxial, 200mW output at 230Mc/s) though—Mullard have successfully adapted their alloy-diffusion technique to give devices capable of operation at $1,000\text{Mc/s}$. These development transistors, whose bases are of the order of $\frac{1}{2}\mu$ wide, were demonstrated giving a noise factor of 6.8dB at 815Mc/s . At 1Gc/s a

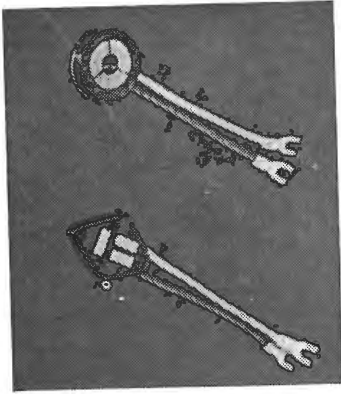

Two of Semiconductor Thermoelements "Frigistors" designed for cooling of power transistors and diodes.

gain of 10dB/stage can be obtained. Planar assembly techniques, too, help to raise frequency limits: here the component parts of the transistor are laid down in the form of very narrow "stripes" of material, usually about 10μ thick, 7μ long and as little as 1μ wide (G.E.C., Ferranti and Plessey). Voltage ratings too are rising—Lucas, for instance, were showing a n-p-n silicon power transistor for which they claimed a collector-voltage rating of 500 (dissipation 50W).

Voltage surge onset caused by switching in equipment which uses semiconductors, can have results which, apart from being ruinously expensive, are calculated to turn the soberest engineer into a raving lunatic. To avoid this disastrous series of events A.E.I. have designed a voltage surge detector using tunnel diodes. The surge voltage is attenuated and the positive swing suppressed, the negative pulse being then applied to a tunnel diode, biased past the upper stable point by a variable supply. If the negative surge pulse exceeds the bias voltage the tunnel diode is switched to the lower stable point, and the fact that the diode has switched is indicated by a meter in the collector of a transistor amplifier.

Hall-effect devices are usually arranged to give scalar multiplication—an input to, say, the y-axis of an element will appear at the x-axis in proportion to the magnetic field applied in the z-axis. However, single-sideband signal generation can be achieved by vector multiplication, to which Hall-effect devices are suited. If a cube-shaped element is employed with a rotating

magnetic field applied by pole pieces at four of the faces, and a rotating electric field is applied at the four edges between these faces, then a vector-multiplied output will appear between the two free faces. A.E.I.'s Research Laboratory's stand carried an exhibit in which this method of vector multiplication was used for direct frequency translation to produce a s.s.b. signal, with the carrier (about 20kc/s) fed to the coils and the a.f. to the edges. If the vectors rotate in the same direction the output is the difference frequency (one sideband) whereas contra-rotation gives the sum (the other sideband). Detection, naturally, can be achieved by the same device—the a.f. input terminals just become a.f. output. Combination of the two resultant quadrature a.f. signals, in the phase-shift networks used to produce quadrature signals for modulation, completes the process.

Cooling of semiconductors by Peltier-effect devices is easy with two components shown by Semiconductor Thermoelements. Named "Frigistors," these are couples en-

capsulated in thermal insulation with cold junctions arranged to contact the device to be cooled. As can be seen from the photograph the Frigistors are shaped to match transistors in Type T03 cans and diodes having a centre-stud fixing. Cooling rate is 3-4W at 17A, 0.33V.

Electron emission from cold semiconductor reverse-biased p-n junctions was shown by the G.E.C. Hirst Research Centre. Even with a bias of only a few volts, a very high field is produced across the p-n junction. This accelerates any free electrons there to velocities which would only be obtained by heating the semiconductor if temperatures of several tens of thousands of degrees were used. Unfortunately, in general, before such "hot" electrons can be emitted, they have to pass through the n-region where they tend to lose some or all of their energy in collisions, even if the n-region is made very thin. This does not, however, apply around the edge of the junction where electrons can immediately be emitted with a consequently much greater energy.

THERMIONIC DEVICES

Experimental storage tube for electrical read-in and -out was shown by 20th Century. Of double-ended construction, a feature of this tube is its great flexibility and potentially high resolution. A c.r.t.-like gun is used to read-in the signal, which is stored on a target between the two guns by conduction in the target caused by electron bombardment from the high-speed beam. This causes charges to appear on the other side of the target, which are read-off by an assembly not unlike a camera-tube. A low-velocity beam (like a vidicon) could be used, but this has the disadvantage of being affected

easily by magnetic fields: this could render the use of the tube difficult for scan conversion as the stray field of the read-in side might upset read-out. Consequently the high-velocity image-icoscope type of read-out is used—the higher voltages needed for this are no disadvantage as potentials more than sufficient for read-out are used on the read-in gun. The target itself is unusual: 20th Century have developed a means for not only making it very thin, but also doing away with the resolution-limiting support mesh. The tube can handle, merely by adjustment of working conditions, half-tone or "soot-and-

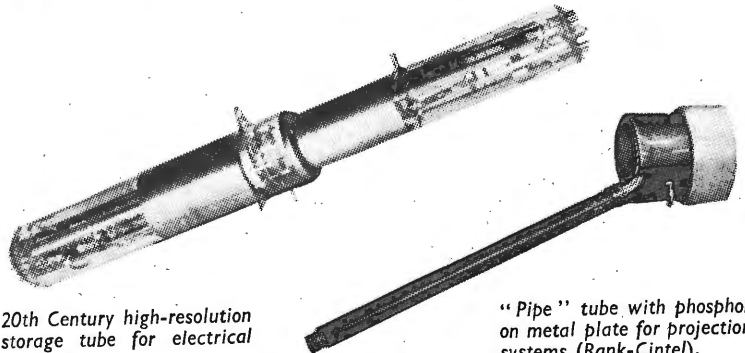

20th Century high-resolution storage tube for electrical read-out.

"Pipe" tube with phosphor on metal plate for projection systems (Rank-Cintel).

whitewash" only. Its uses, of course, are legion: in addition to scan conversion, bandwidth compression, improvement of signal-to-noise ratio by integration of repetitive phenomena and analysis of transients are just a few.

Split-beam c.r.t.s provide a convenient means of producing double-beam facilities on a c.r.o. without beam - switching disadvantages. Usually, though, only asymmetric deflection is possible with a split-beam tube: new development-type tubes from Electronic Tubes Ltd. have the beam divided at the final anode and bent so that a pair of miniature y-plates can be provided for each beam, thus allowing symmetrical deflection.

Increasing c.r.t. beam current to obtain high brightness heats up the phosphor, so reducing its efficiency:

it is even possible to "burn" a hole through a glass faceplate if the beam is allowed to rest on one point. In a "pipe"-shaped tube by Rank-Cintel the phosphor is coated on to a metal plate which provides better cooling than can glass so that mean cathode currents up to 1mA at 30kV e.h.t. may be used. It is thus necessary to view the display through a window in the "bowl" of the tube which forms a valuable light shield. Naturally, trapezium correction is necessary, as is focus-current modulation. This tube is made, as is another of very high mechanical precision, by "sticking together" the parts with a powdered glass "cement" of melting point high enough to allow satisfactory outgassing but low enough to avoid distortion of optically-worked components and permit the joining of materials of differing coefficients of expansion.



Pulse rate meter by Burndeft, showing carbon transducer.

MEDICAL AND BIOLOGICAL ELECTRONICS

A receiver designed to accept information from frequency-modulated radio pills was shown by Electronic Instruments in conjunction with Solartron, and takes the form of a double superhet f.m. receiver. The r.f. signal of between 300 and 600 kc/s is amplified and an i.f. of 1.6 Mc/s mixed with the output of a beat frequency oscillator. The resulting frequency is converted into constant area pulses and frequency discriminated by a diode pump integrator. A transistor forming part of the resistor leg of the diode pump R.C. network is cut off by a second diode pump if transmission ceases, the charge remaining on the storage capacitor being held constant and used to operate a recorder.

The need to collect data from animals and human beings in free movement has led to a number of miniature telemetry transmitters. However, because of the smallness of many physiological voltages these have required separate amplifiers and modulators. The Bio-Engineering Laboratory of the Medical Research Council has developed an f.m. transmitter which can be directly modulated by physiological phenomena producing 1mV and over. The transmitter uses the voltage capacitance characteristic of a silicon junction diode to modulate an 80Mc/s oscillator with a sensitivity of 50kc/s/mV. Depending on the nature of the sig-

nals being transmitted up to three quantities can be handled by one channel.

Pulse-rate measurement, which can be reliably carried out at low cost in the operating theatre is the aim of the Burndeft Body Pulse Meter. The transducer consists of a carbon pressure pad which is pressed against the terminal phalanx of any finger

or thumb. The pressure changes due to the pulse causes varying resistance in the transducer which is connected in a resistance bridge, a meter connected in the bridge circuit providing a continuous reading of pulse rate. If the pulse meter is used in conjunction with a sphygmometer the equipment can also be used for blood pressure measurement.

Designed for such applications as rapid tissue and cell disintegration and disruption, bacterial activity stimulation, the acceleration of enzyme activity, etc., the Dawe Instruments' Soniprobe consists of a 25 kc/s transistorized oscillator producing a mean power of 75 watts. The oscillator, which is pulsed at 100 c/s, is used to drive a piezo-electric transducer, which in turn is coupled by a mechanical energy transformer to a stainless steel tool bit. The device is hand held or stand mounted.

MATERIALS AND MATERIAL TESTING

Glass-insulated wire was shown by two firms—Glass Developments and G. V. Planer. The insulation of the Planer product is formed by an electro-deposition process, while the Glass Developments wire is formed by continuous "casting" of a copper or manganin filament inside a glass jacket. The break-down strength of the glass insulation is 5kVd.c. which means that no special interleaving is required when the wire is used for high voltage transformers. It was pointed out by Glass Developments that in the finer gauges the tensile strengths of copper and manganin are comparable with that of steel.

Metal hardness testing by established methods such as the Brinell and Rockwell methods are rather lengthy

procedures and the need for surface grinding may be damaging on a small component. In a magnetic hardness tester produced by Fleming Radio the method adopted is to magnetically saturate the specimen, which is then dropped from a fixed height through a pick-up coil in which a pulse is induced of a height which is proportional to the remanance in the specimen. As remanance is proportional to hardness the pulse height is a measure of hardness. In a fully automatic device, the pulse could be applied to two trigger circuits, the thresholds of which could be pre-set to upper and lower limits, and a bin selector fed by the trigger outputs. The only preparation required is the removal of oxide coatings.

"Belling-Lee"

FLEXIBLE TERMINAL BLOCKS

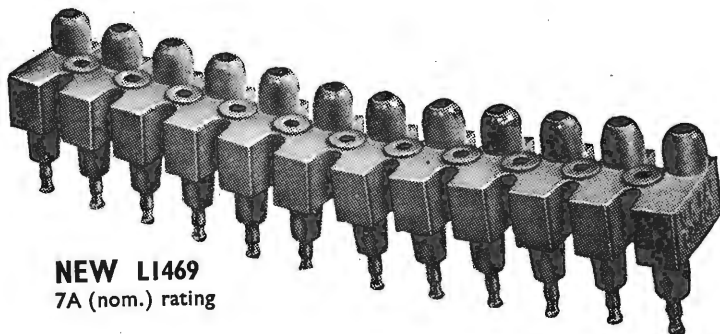

NEW LI469
7A (nom.) rating

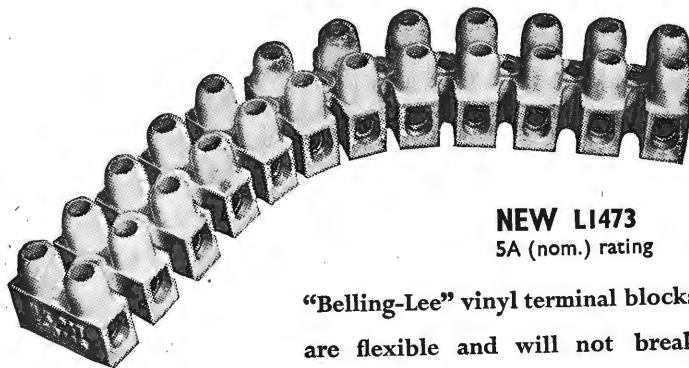

NEW LI473
5A (nom.) rating

- **GREATER FLEXIBILITY**
- **LIGHTER WEIGHT**
- **IMPROVED PERFORMANCE**

"Belling-Lee" vinyl terminal blocks are flexible and will not break under shock or impact, and the terminal screws are vibration proof. The right angle pattern conveniently overcomes the problems of bringing leads through a panel, obviating the need for separate cable bushes, as well as eliminating all risk of damage to internal wiring. Full technical details on request.

Most "Belling-Lee" products are covered by patents or registered designs or applications

BELLING & LEE LTD
GREAT CAMBRIDGE ROAD, ENFIELD, MIDD., ENGLAND

Telephone: Enfield 5393 • Telegrams: Radiobel, Enfield

"BELLING-LEE" NOTES

No. 38 of a series

Recording Transients

Let us explain right away that this is not an excursion into "hi-fi." We have used the word 'transients' in its broad sense, meaning phenomena which are not lasting, and we are concerned in particular with those of short duration, i.e. measured in milli-seconds.

There are various ways of recording transient events, but we needed a durable visual record, which would be rapidly available for analysis without involving undue processing delays, and the equipment had to be capable of handling several different aspects of the phenomena, or a number of related events, separately but simultaneously. At the high speeds involved, inertia effects had to be excluded, and our requirements were met by a standard multi-channel optical system employing twelve high speed reflecting galvanometers to traverse the surface of a sensitised paper tape with beams of ultra-violet light. The traces become visible in a matter of seconds, and are retained for long periods if shielded from undue further radiation; they may be fixed by chemical processing for permanent storage, if required.

The light does include components in the visible spectrum, and each beam, after reflection at the galvanometer, is split into two paths, one traversing the tape, and the other being directed on to a ground glass screen on which a deflection may be instantly observed. The galvanometers possess a linear response to signals of frequencies up to 3,500 c.p.s., which covers a steep enough wave front for our present purposes.

To see a reasonable amount of detail of an event which takes place in a milli-second, the record must certainly occupy not less than 1/10in. of tape; this means that the tape would be expended at a rate of 10in. per second, and so it is desirable to restrict the period of recording as nearly as possible to that of the event in order to minimise waste, and to avoid having to search a vast expanse of material to find what has been recorded. This cannot be done with this kind of gear when random phenomena are being investigated, but we are concerned with events which can be made to occur at our convenience, such as the rupturing of fuses. Even so, the synchronisation of the experiment and the recording did present certain problems, and these and their solution will be discussed next month.

Advertisement of

BELLING & LEE LTD.

Great Cambridge Rd., Enfield, Middx.



**BETWEEN
YOU
AND ME...**

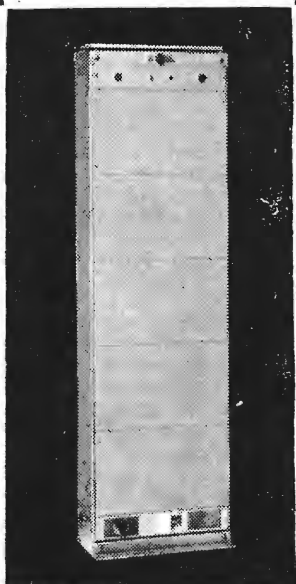

... "it's a good job we specified Multi-channel Radio. In conditions like these we should never have got through on a line circuit".

Disruption of line communications by accident, fire, flood, hurricane or, as in this Canadian scene, by sheer weight of snow, is usually unpredictable and always costly. In parts of the world where such hazards are expected and particularly when the terrain is difficult and the construction of pole routes impracticable or prohibitively expensive, administrations are specifying Multi-channel Radio Systems.

The A.T.E. Type 900 is a wideband VHF/UHF Radio equipment with in-built transistor multiplexing equipment capable of carrying 1 + 4 speech or telegraph channels and is designed to meet small junction radio requirements for just this kind of service.

Type 900 covers the frequency bands 156-184 Mc/s, 220-260 Mc/s and 430-500 Mc/s. It is designed for continuous mains operation under all climatic conditions and is robust, compact and easy to maintain.

For further information write for Bulletin No. P.I.B. 104

AUTOMATIC TELEPHONE & ELECTRIC CO. LTD.

Strowger House, Arundel St, London, W.C.2. Tel: TEMple Bar 9262

SPECIFY A.T.E. FIVE CHANNEL TYPE 900 FOR YOUR TIE LINE AND MINOR JUNCTION REQUIREMENTS



AT 14081

Feedback, Distortion and Allied Topics

By THOMAS RODDAM

THE question of distortion is one which has bothered designers since the earliest days of sound amplification. The introduction of multi-channel telephone systems depended on improved methods of distortion control, analysed now as intermodulation, while later still the designers of analogue computers concerned themselves with the linearity of their systems. It may be difficult for readers who are under the age of 40 to realize that negative feedback was an invention, that this whole wide use of feedback amplifiers has a sharply defined beginning. It is rather hard for all of us to realize that this invention was not made until after the theory of filter design had progressed beyond the point which still satisfies most of us who design filters from the simple rules in the reference books.

On and off through the years I have recorded, in pages now yellowing, some notes on various aspects of these problems. Nowadays my jottings tend to begin when I have said "these things we hold to be self-evident", only to discover that they are not so obvious at all. I have, for example, recorded a convenient way of working out the distortion and intermodulation in a valve stage: I have discussed why negative feedback does not reduce distortion as much as you expect. The combination of these two results is straightforward: or is it? When I tried it on a standard reader I keep for the purpose, with the benevolent aid of the Commissioners of Inland Revenue, I found that it needed the full treatment. As I cannot and you will not refer to the previous articles, let us go through the whole question of finding just how much distortion reduction we can get for how much feedback.

The first step is to find out how much distortion we actually have. When I worked this out previously for valves I worked in terms of the mutual conductance: the corresponding exercise now, for transistors, might be in terms of current gain or, more conveniently, in terms of mutual impedance with a given load, which would mean using the change-of-collector-volts to change-of-base-current ratio. There is nothing to lose by keeping the analysis general and we shall therefore work in terms of the transfer gain, which is simply the size of the change in output signal produced by a unit change in input signal. The unit must naturally be very small. For a valve we might take the unit as 10mV at the grid, measure 50μA/10mV as the mutual conductance and then modify the way we describe it to 5mA/V: for an amplifier we might find it more convenient to measure in terms of 1mV input, to get a gain of, say, 100mV/1mV or 100 times.

We are quite accustomed to the idea that the mutual conductance of a valve varies with the bias. Expressed in more general terms, the differential gain varies with the instantaneous signal value. This characteristic is the one we are going to consider in detail. First of all, though, a special superposition

theorem is needed. It may seem almost (or completely) obvious but it saves carrying a lot of dead terms through the mathematics.

$$\text{If } S_{\text{out}} = (\mu_1 + \mu_2)S_{\text{in}}$$

$$\text{then } S_{\text{out}} = \mu_1 S_{\text{in}} + \mu_2 S_{\text{in}}$$

Suppose that μ_1 is a constant while μ_2 depends on the value of S_{in} . The term $\mu_1 S_{\text{in}}$ contains no distortion and can be neglected in favour of $\mu_2 S_{\text{in}}$, the distortion-producing term, as long as we are just calculating the harmonics. An example will show how we make use of this.

The characteristic shown in Fig. 1a might well be the mutual-conductance/bias characteristic of a valve. In general language it is a gain/input-signal characteristic for a system having a gain of μ_1 at the centre of the range, which will be the nominal working point. This can be split up in the way shown in Fig. 1b, in which we see that we have

$$\mu_1 = \text{constant and}$$

$$\mu_2 = \kappa_2 S_{\text{in}}$$

We consider now a signal of the usual form

$$S_{\text{in}} = a \cos \omega t$$

and we obviously have

$$S_{\text{out}} = \mu_1 a \cos \omega t \dots \dots \dots (\text{undistorted})$$

$$+ \mu_2 a \cos \omega t \dots \dots \dots (\text{distorted})$$

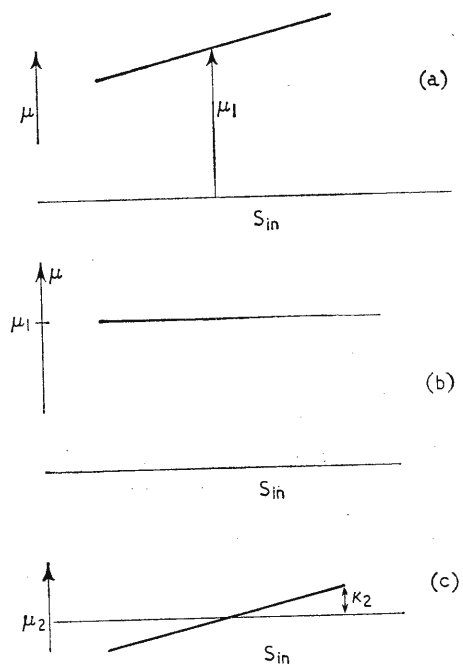

Fig. 1. Typical gain curve (a) can be broken up into constant factor (b) and linear variable (c).

From the expression for μ_2 the distorted part of S_{out} is:—

$$\begin{aligned} \kappa_2 \cdot a \cos \omega t \cdot a \cos \omega t \\ = \kappa_2 a^2 \cos^2 \omega t \\ = \kappa_2 a^2 (\cos 2\omega t + 1)/2 \end{aligned}$$

There is thus a second harmonic term of $\kappa_2 a^2 (\cos 2\omega t)/2$ to compare with a fundamental of $\mu_1 a \cos \omega t$ so that the distortion will be

$$(\kappa_2 a/2\mu_1) 100\%$$

The gain/instantaneous-signal characteristic may well be more like that shown in Fig. 2a. After μ_1 and μ_2 (the overall slope) have been taken out we are left with the shape shown, as μ_3 . This is of the form $\mu_3 = \kappa_3 S_{in}^2$, where κ_3 is easily found by substituting known values for μ_3 and S_{in} . This harmonic term gives us:—

$$\kappa_3 a^3 \cos^3 \omega t = \kappa_3 a^3 (\cos 3\omega t + 3 \cos \omega t)/4$$

You will notice that the μ_3 term produces a small contribution to the fundamental. The error in ignoring this is not of any practical significance; it is of the same order and same kind as the error introduced by our loose way of accepting either the harmonic/total or harmonic/fundamental ratio and treating the figures as equivalent even though one type of test equipment measures one, another the other. The simple result is that the third harmonic is $(\kappa_3 a^2/4\mu_1) \cdot 100\%$ of the fundamental.

It is merely a matter of patience to carry this sort of analysis further and to see the factors which govern the higher harmonics and the intermodulation. I have already dealt with intermodulation in a long-lost article and for the present I want to go on in a different direction. Suppose that you have constructed a bare amplifier and you want

to know how much feedback is needed to get a given performance. Let us write down the standard expression $\mu_t = \mu/(1 + \mu\beta)$ or $1/\mu_t = (1/\mu) + \beta$. To give us something solid to talk about we will use the characteristic shown in Fig. 3 which has $\mu_1 = 100$ and $\kappa_2 a = 20$ at the limits of the defined range. The distortion is all second harmonic and is just 10%.

We now make up a simple table:

	80	100	120
μ			
$1/\mu$	0.0125	0.01	0.00833
$(1/\mu) + 0.1$	0.1125	0.11	0.10833
μ_t	8.89	9.09	9.23

This corresponds to what we often call, rather loosely, 20dB of feedback. We can plot out the shape of μ_t in Fig. 4, and we see that instead of the straight line of Fig. 3a we now have a curve as we found turning up in Fig. 2. We have already seen that this corresponds to the production of third harmonic, which was absent in the system without feedback. As the amplifier itself can only produce simple product terms, this third harmonic must be the result of feeding back second harmonic to the input and intermodulating it with the fundamental on what is in effect a second passage through the amplifier. The figures in the table enable us to work out the various coefficients and we come to the conclusion that the second harmonic distortion is 0.92% and the third harmonic is 0.16%. I think it will be agreed that this is a good deal better than the 10% second harmonic we started with, but I am chary of putting a number to the improvement; the main reason why we add the harmonic terms on an r.m.s. basis is that it is convenient to build our measuring instruments in this way. It used to be suggested that we should apply weighting to the individual harmonics because the higher the harmonic the more unpleasant the effect but this sort of discussion has now died away as we have realized that there is not much point in determining the difference between shocking reproduction and absolutely horrible.

There is no reason why we should worry about the difficulty of determining the form which Fig. 3 takes for a practical amplifier. We can measure the small-signal gain and we can also measure the distortion at our maximum signal level. An oscilloscope connected to the distortion-factor bridge will tell us whether the distortion is mainly second or third harmonic. It is not really too difficult to estimate the proportions when both must be taken into account. From this information we can get the form of Fig. 3 immediately. Suppose, for example, that the small-signal gain is 100 and that we have 10% second harmonic distortion. Then $(\kappa_2 a/2\mu_1) = 0.1$ and thus $\kappa_2 a = 20$. At the ends of the gain-signal characteristic the gains will be 100 ± 20 , the figures already used in the table. From this point, of course, the procedure is exactly as before.

Intermodulation calculations are handled in exactly the same way except that the expressions are slightly different. They are not too difficult to work out for yourself so long as you can remember, or look up, the standard trigonometrical forms like $\cos(A + B) = \cos A \cos B - \sin A \sin B$ leading, of course, to the one you need, which is

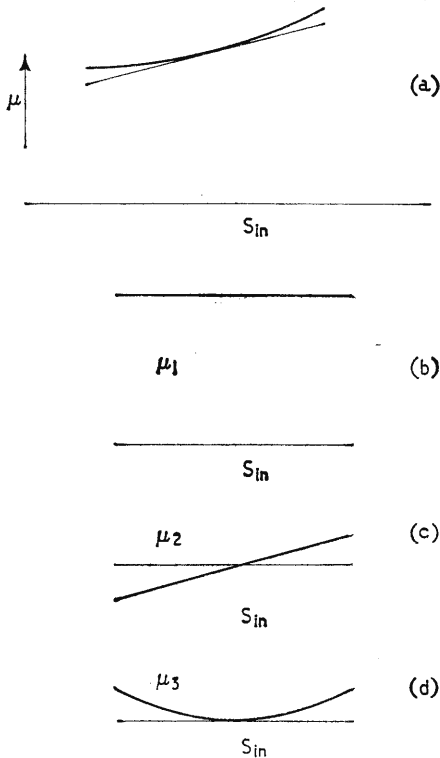

Fig. 2. Here gain curve (a) is broken up (b), (c) and (d) as in Fig. 1. Additional term μ_3 gives third harmonic distortion.

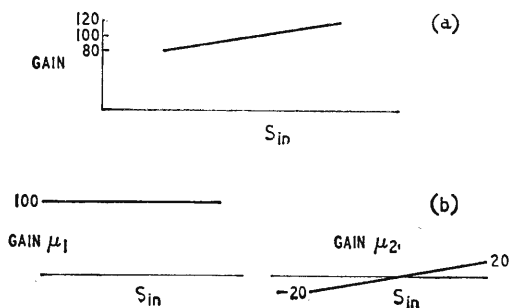

Fig. 3. (a) Gain curve for typical amplifier with nominal gain of 100: true gain ranges from 80 to 120. (b) Broken-up gain curve.

$\cos A \cos B = [\cos(A + B) + \cos(A - B)]/2$. Harmonic distortion is just a special case with $A = B$ and the first-order sum-and-difference products are each equal to the second harmonic when the peak excursion is the same. I have covered this in much more detail before and I want to use some space for a rather different topic which turns out to impose much more rigorous conditions on the unhappy designer.

An amplifier with sufficient gain has the property that it will give a useful output for practically no input. When an input signal is applied through a substantial impedance the fact that the amplifier needs almost no input must imply that all the signal appears across the impedance. Several sources can be used without mutual interference and they also can provide, by adding suitable networks, differential and integral terms. The simplest possible version of this sort of computing amplifier, the basic stuff of the whole field of analogue computers, has just one input and one output. The applications of systems of this kind are so wide that it is difficult to choose an example which can fairly be marked "typical". Let us assume that our experiment is the determination of the behaviour of an anti-vibration system with different loadings and that we have turned the spring deflection into a voltage, somehow or another, and are using the amplifier to drive a recorder.

When we load the system we shift the working point. Let us stick to the amplifier of Fig. 3 and assume that our three loadings give us values of $\mu = 80, 100$ and 120 . We put on over 20dB of feedback, to give us, in ordinary terms, only 1% distortion. We produce a unit vibration signal and we find that the recorder shows records of 8.89, 9.09 and 9.23 units (compare with the table for μ_i).

The range of these is 0.34, which is about 3.7%. We should be tempted to believe that, as the amplifier distortion is only 1%, there is a really significant change in input signal, but the way we have reached this 3.7% shows that this is just not so.

The audio-frequency amplifier designer will recognize this effect as a variation on the intermodulation theme in which one of his two intermodulating signals has been replaced by a simple shift of the working point, a signal of zero frequency. The two side-bands with which he is concerned now fall on top of each other. He will not be surprised to see that the figure for harmonic distortion gives an optimistic picture of the situation.

It is an exercise for the student to work out the effect of more feedback, say 30dB, and to see how this will improve the situation. One of the advantages of the method is that the calculation is extremely easy, requiring nothing more than a set of reciprocal tables and the capacity to add two numbers together. It has always been my belief that if you can calculate something you should and it has been my experience that if a calculation looks difficult a good many engineers will shut their eyes and start building in the hope that it will all be all right on the day. In my bursts of literary energy, therefore, I feel that these useful and important calculations which really call for no thought are worth drawing to the attention of those who would if they could.

What the mathematician might call a trivial special case because it is especially simple has, to my mind, exceptional significance. In the September 1961 issue of *Wireless World* "Cathode Ray" discussed the question of whether we should consider transistor as voltage or current operated. Most transistor-amplifier designers nowadays use local negative feedback produced by a resistance in the emitter lead. Apart from its importance in stabilizing the working point this also holds the gain at a more defined level so that "limit" transistors do not upset the stability of a multi-stage amplifier with overall feedback.

A simple amplifier of this type will have an apparent transconductance of $(1/g_m + R_e)^{-1}$. In a rearrangement of this

$$1/g_t = 1/g_m + R_e$$

an equation which is exactly the same as the standard feedback amplifier expression quoted earlier. It does not require much consideration to see that once we have a few values for g_m at different bias levels we can construct the characteristic for g_t by elementary arithmetic. We can also construct a table of distortion at various signal amplitudes.

Some of the arithmetic is right down to the do-it-in-your-head class. Suppose, for example, we have 1,000- Ω emitter resistance and 10,000- Ω collector resistance. A typical transistor has a g_m reaching 50 at peak-signal current, so that $1/g_t = 1,020\Omega$: we might drive it down to a g_m of 25, giving $1/g_t = 1,040$. In this arrangement we have $\kappa_2\alpha = 10$ and the distortion is only $\frac{1}{2}\%$. The gain is equally easily obtained as g_t is almost 1mA/V, giving us a voltage gain with a 10-k Ω collector load of just about 10 times.

It all stops being so simple once we start cascading

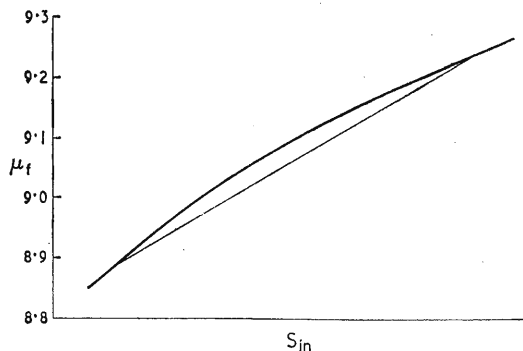

Fig. 4. With 20dB of feedback curve of Fig. 3a becomes this, showing appearance of a third harmonic term.

stages. The single stage with its input impedance of about $\beta \times 1,000\Omega$ will be very happy fed from a voltage source, but fed from another similar stage, which will look like a 10,000- Ω source, variations in the current gain will play havoc with the distortion. The voltage at the base electrode will itself be pre-distorted by the varying impedance and the fact that the gain does no more distorting will not help.

There is room here for a good deal of ingenuity, mostly misplaced. We will naturally choose a type of transistor having constant current gain in the region we want for operating. For the OC200, taken at random, the current gain has a flat maximum at just over 1mA, while for the OC83 it is about

40mA. Most manufacturers appear to discourage the use of g_m because they are careful not to give us any curves. You can now go on to be very clever, though I will not go with you, and try to balance the remaining g_m distortion against the β distortion. It is just a question of finding the best working point, away from this flat maximum. It is better, of course, far far better, to find some more gain and put on some more overall negative feedback.

Calculations of the type discussed are so very easy that I find it almost impossible to understand why they are not an automatic prelude to any amplifier construction. One day they will be, and when that day dawns I shall stop writing. I join you in your hopes.

TECHNICAL NOTEBOOK

Light Amplification by a factor of two has been obtained by Drs. P. P. Kisliuk and W. S. Boyle of the Bell Telephone Laboratories. Ruby optical masers similar to that described on p. 614 of this section of our December 1960 issue were used. Although such masers, when oscillating, must amplify sufficiently to make up for losses at their partly-silvered end mirrors, such amplification has not yet been measured directly. One problem lies in distinguishing any light produced by maser amplification from that produced by the normal fluorescence of ruby. In the new experiment this problem was solved by using a ruby maser oscillator to provide a coherent input source bright enough to swamp any fluorescent light. The amplifying maser was similar to the input maser except that the ends of the ruby were not silvered. The output light was compared with a (partly-reflected) portion of the input light using two photomultipliers, and the gain measured by comparing the input/output ratios with and without the amplifier maser in the input light beam.

Digital Q-meters are discussed in an article by T. F. Heiting in the issue of *Electronics* for September 29, 1961. Direct-reading results are obtained for Q-values greater than 10, with the attendant advantages of rapidity of measurement and freedom from reading error. It is shown that, in a damped train of oscillations, the ratio of amplitudes between which the number of cycles is equal to Q is 23.14, or -27.3dB. The sequence of operations is initiated by a free-running pulse generator, which shock-excites the tuned-circuit under test. When the amplitude of the damped oscillations has fallen to a reference level, a trigger circuit opens a gate, whereupon the oscillatory signal is passed to a counter. As the

amplitude decays to 4.321% of that when the gate was opened, a second trigger level closes the gate, the displayed count giving Q directly. Accuracy depends on the Q, and is between $\pm 12\%$ for a Q of 10 and $\pm 2\%$ for a Q of 1000. Successive measurements tend to average out, and greater accuracy is obtained in this way.

Remote Scaler Read-out was described by Brun at the International Atomic Energy Conference on Nuclear Electronics held at Belgrade in May 1961. The method employed affords non-destructive read-out of a binary scaler and only necessitates the addition of two leads to each scaler. A pulse generator feeds a delay-line which has n taps, where n is the number of bits to be read. The delay-line taps and the toggles feed n "AND" gates, whose outputs are taken to an n -input "OR" gate. The signal from the "OR" is now fed to a second, identical delay-line which again provides one input to each of n "AND" gates, whose outputs are taken to the display devices, the order being the reverse of that in the scaler. At the instant which all the pulses from the scaler delay-line are stored in the remote delay-line, a pulse is fed to the second input of each of the remote "AND" gates, and the read-out devices are set up.

Cancellation of Loudspeaker Resonances is possible according to an article by W. C. Trautman in the October 1961 issue of the *Journal of the Audio Engineering Society*. A weight is suspended symmetrically inside the loudspeaker cone by attaching it to a flexible flat diaphragm; the diaphragm compliance and weight being chosen to provide a suitable anti-resonance at the loudspeaker bass resonance. This anti-resonance is also suitably

damped by making the diaphragm porous so as to add resistance to the motion of the weight

Eye-ball Pressure Measurement employing the pressure/frequency characteristic of a crystal oscillator was described by D. E. Newell *et al* in the September 8, 1961, issue of *Electronics*. A probe is applied to the eyeball, flattening a 3mm diameter circular area, and the resultant pressure is transferred by a glass rod to the quartz crystal, which is in a 3-Mc/s Colpitts circuit. The output of this probe oscillator, which will be varied by an amount dependent on the pressure on the crystal, is multiplied by 12 and mixed with the signal from a second oscillator working at 36Mc/s. The difference, which is now 12 times the original deviation, is used to trigger a monostable flip-flop, providing constant-energy pulses to an integrating discriminator. The output can be calibrated and displayed on a meter and pen recorder.

Stabilized-current supply developed by N. Bett at Cavendish Laboratory, Cambridge, has its stabilizing transistor switched alternately from saturation to cut-off to keep power dissipation low. The potential drop across a standard resistor is compared with a standard cell—if the potential across the resistor rises the "on" time of the transistor is decreased, if the potential decreases the "on" time is increased. An unusual feature of the circuit is that the difference amplifier and stabilizer transistor are made self-oscillating by the connection of a capacitor between the current-stabilized output (before smoothing) and a suitable point in the difference amplifier: variation of current is then used to vary mark-space ratio of this 800c/s multivibrator.

WIRELESS WORLD, MARCH 1962

MANUFACTURERS' PRODUCTS

NEW ELECTRONIC EQUIPMENT AND ACCESSORIES

Cable Covering

DESIGNED for the protection of wiring against dusty and humid conditions, Hellermann "Helazipp" takes the form of a p.v.c. tape with interlocking beading along each edge, by means of which the tape may be wrapped round a cableform and "zipped up." Available in either black

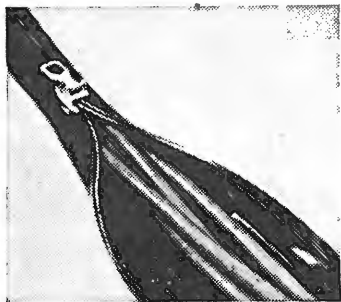

"Helazipp" cable sheathing.

or transparent p.v.c., the tape will cover cableforms of $\frac{1}{8}$ in to 3in diameter. Further information can be obtained from Hellermann Ltd., Gatwick Road, Crawley, Sussex.

Thickness Gauge

ULTRASONIC single-sided thickness measurement is provided by the Dawe Type 1103 gauge, which uses transistors. Direct meter reading of the thickness of steel, aluminium and copper is obtained by switch selec-



Dawe 1103 thickness gauge, showing the transducer.

tion, and the instrument can be calibrated to give the thickness of other materials. A crystal transducer working between 2 and 4Mc/s transmits into the material. The frequencies at which resonances occur are related

to the material thickness, the resonances being indicated by headphones and by the meter. Thickness between 0.09in and 5in may be measured at an accuracy of 3 to 5% of the wall thickness. Details are obtainable from Dawe Instruments Ltd., Harlequin Avenue, Great West Road, Brentford, Middlesex.

Frequency Measuring Receiver

COMPOSED of several instruments from the Racal range, the RA.78 Frequency Measuring Receiver will handle frequencies from 10 kc/s to 30 Mc/s, at an accuracy of better than 5 parts in 10^7 . An RA.17 receiver is tuned to the received signal by comparison of the 100kc/s i.f. with a crystal standard in an SA.77 comparator. The frequency of the receiver v.f.o. is measured on an SA.21 digital meter which, after allowing 2.1 Mc/s offset for the 2nd and 3rd i.f.'s, indicates the frequency of the received signal directly. For increased accuracy, an external standard frequency may be injected. Leaflet 168C2, from Racal Engineering Ltd., Bracknell, Berks, gives a full description.

Platform-scale Meters

DESIGNED for use in aircraft, and in situations where vibration or a high level of atmospheric pollution are to be expected, the Pullin Series 125 hermetically-sealed meters are suitable for use in temperatures between -40°C and 85°C . A platform scale is used both to avoid parallax reading-error and to increase clearance between the scale and pointer, which is about three times the normal length. The instruments are supplied as a.c. and d.c. voltmeters, and as direct current meters

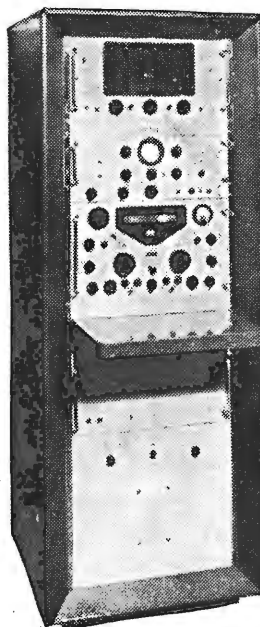

Above: One of the Pullin Series 125 hermetically-sealed meters.

Left: Racal RA.78 frequency measuring receiver. The indicator is the top panel with, below it, the comparator.

with a maximum sensitivity of $50\mu\text{A}$. Further details can be obtained from Measuring Instruments (Pullin) Ltd., Electrin Works, Winchester Street, Acton, W.3.

Batteries for Television

DESIGNED specifically for portable television receivers, two new DEAC rechargeable batteries are available in either 4- or 6-Ah capacities, providing 2A or 3A respectively for five hours. They can be stored, charged and operated at temperatures between -30°C and 45°C with no decrease in capacity. No noxious or corrosive fumes are given off and, being sealed, the batteries may



DEAC 5DK6 6Ah rechargeable battery.

be mounted in any position. Full details may be obtained from the U.K. agents—G. A. Stanley Palmer & Co. Ltd., Maxwell House, Arundel Street, London, W.C.2.

Twin Power Supply

TWO completely independent power supplies providing 0-30V at 1A are contained in the Solartron AS1164. The outputs are adjustable in 0.1V increments and can be used separately, in parallel or in series. A proportional control provides overload protection with pre-set current limits. Output impedance up to 100 kc/s is better than 0.35 ohm and the stabilization ratio is greater than 1000:1. The instrument is available at the provisional price of £135 from Solartron Laboratory Instruments Ltd., Cox Lane, Chessington, Surrey.

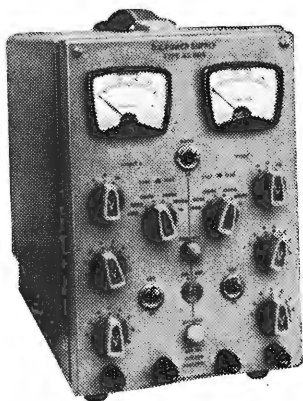

Solartron twin power supply.

New Clamp for C-Cores

ONE method of assembly of C-Cores in shell-type transformers is to use a steel band which is applied under tension and then soldered. Another method employs a screw-type band, but whichever method is adopted

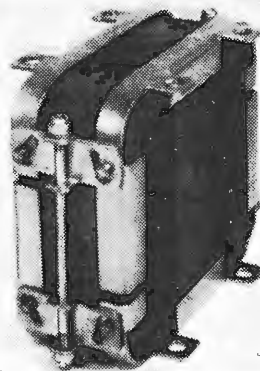

M.K.S. Nucleonics clamp for C-cores.

clamping frames must be used to accommodate a terminal board, and to provide mounting facilities.

M.K.S. Nucleonics Ltd., have introduced a dual-purpose clamping frame which eliminates the banding process and automatically locates and lines up the core elements whilst having only a small number of separate components.

The clamp consists of four pressings designed to fit round the parts of the C-cores and provide mounting holes, each pressing carrying two lugs with heads. Over these heads are dropped plates carrying slots so slanted that, when the bolts joining a pair of plates are tightened, the four clamping plates are forced towards each other. This automatically aligns the C-core sections and closes the gaps between them.

For horizontal mounting with Inter-Service fixing centres a simple adaptor plate is available, as are coil shrouding plates. M.K.S. Nucleonics Ltd., Queens Road, Watford, Herts.

Frequency Comparator

ESSENTIALLY a locked-oscillator, the Raloc permits synchronization of a local oscillator with a broadcast standard such as GBR to within 5 parts in 10^{10} or better. The primary standard is received by a sensitive v.l.f. receiver and compared with the phase of a frequency derived from the local oscillator. A servo system locks the frequency of the oscillator to that of the received standard and provides a pen recording of the phase difference. The servo system provides an output which can be used to synchronize external oscillators to each other within 1 part in 10^8 automatically or two orders better when the controls are adjusted manually. Standard frequency outputs at 1 Mc/s and 100 kc/s are available, each being to the accuracy of the received standard. The instrument is manufactured by the American firm of Pickard and Burns and is available in the U.K. from B. and K. Laboratories, Ltd., 4, Tilney Street, Park Lane, London, W.1.

Raloc frequency comparator and standard.

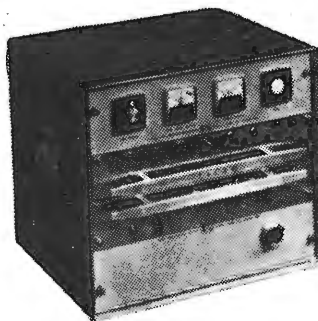

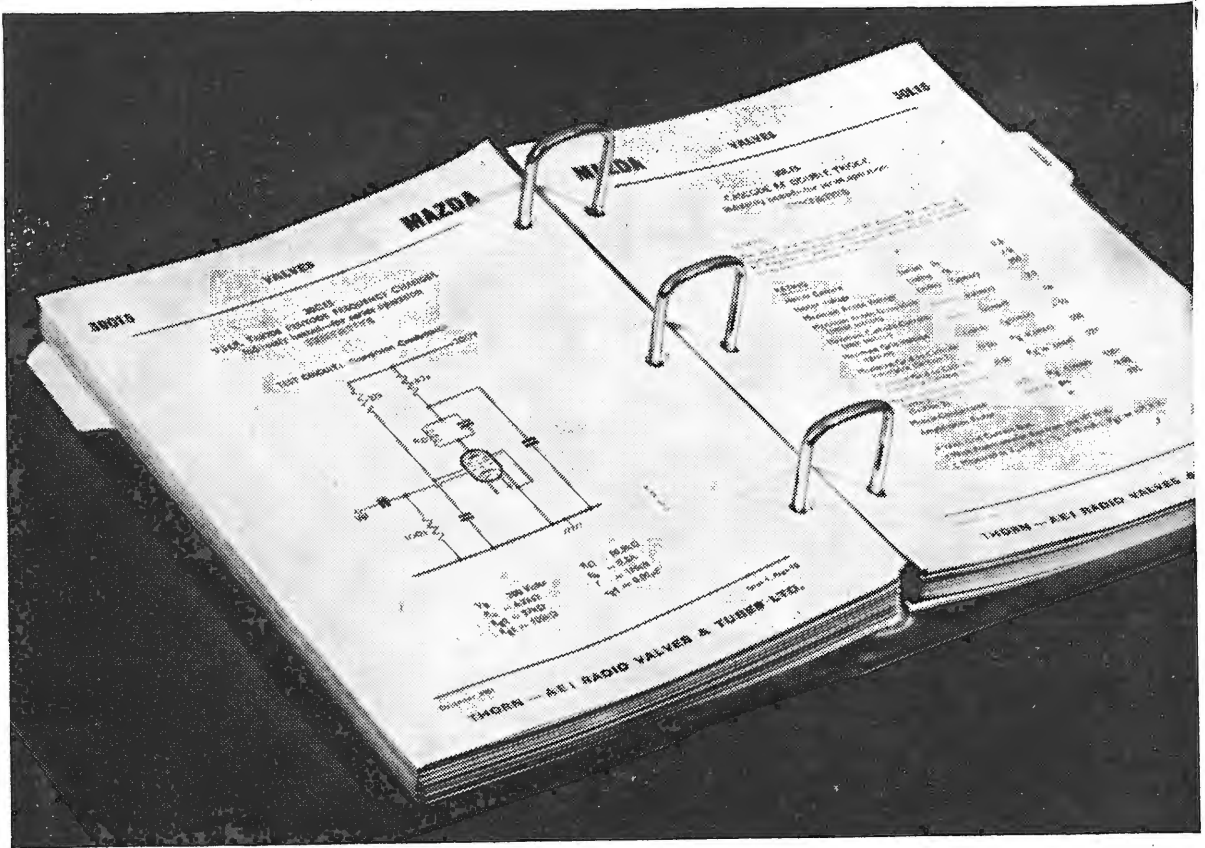

new Mazda handbook

This loose-leaf handbook contains in a single volume comprehensive data on all new and maintenance types of Mazda domestic valves and cathode ray tubes. Numerous characteristic curves and some typical circuits are given. This Mazda Handbook supersedes the section dealing with 'Receiving Types' in the former 3-volume Ediswan (Mazda) Valve Handbook. The new Mazda Handbook has improved layout using a larger page size. The sheets are secured in a smart blue PVC cover by square ring-binders for flat opening and easy insertions.

INITIAL CHARGE covering a handbook complete to date, packing and postage **£1.0.0**

Purchasers of the new Handbook are invited to subscribe on 1st July each year to the follow-up data service. This brings you periodical parcels of data in two forms: (a) *Advance data on new development types, printed in blue.* (b) *Final data on established types, printed in black.*

RENEWAL CHARGE covering subsequent amendments and new issues **£1.0.0**

SPECIAL OVERSEAS EDITION For Overseas use a special edition is published at the same price covering domestic type valves and picture tubes marketed under the EDISWAN brand by our Ediswan Export Division. In this edition precedence is given to European type numbers.

To: Publicity Department,
Thorn-AEI Radio Valves & Tubes Ltd.,
155 Charing Cross Road, London, W.C.2.

Please send me copy(ies) of the handbook ticked—I enclose £1 in payment for each

MAZDA handbook EDISWAN handbook

Name.....

Firm.....

Address.....

Signed.....

BLOCK LETTERS PLEASE

W.W.1

MAZDA VALVE COMMERCIAL DIVISION 155 Charing Cross Road, London WC2 Telephone GERrard 9797

EDISWAN EXPORT DIVISION Thorn House, London, WC2 Telex: London 21521 (Thorn Ldn)

THORN-AEI RADIO VALVES & TUBES LTD

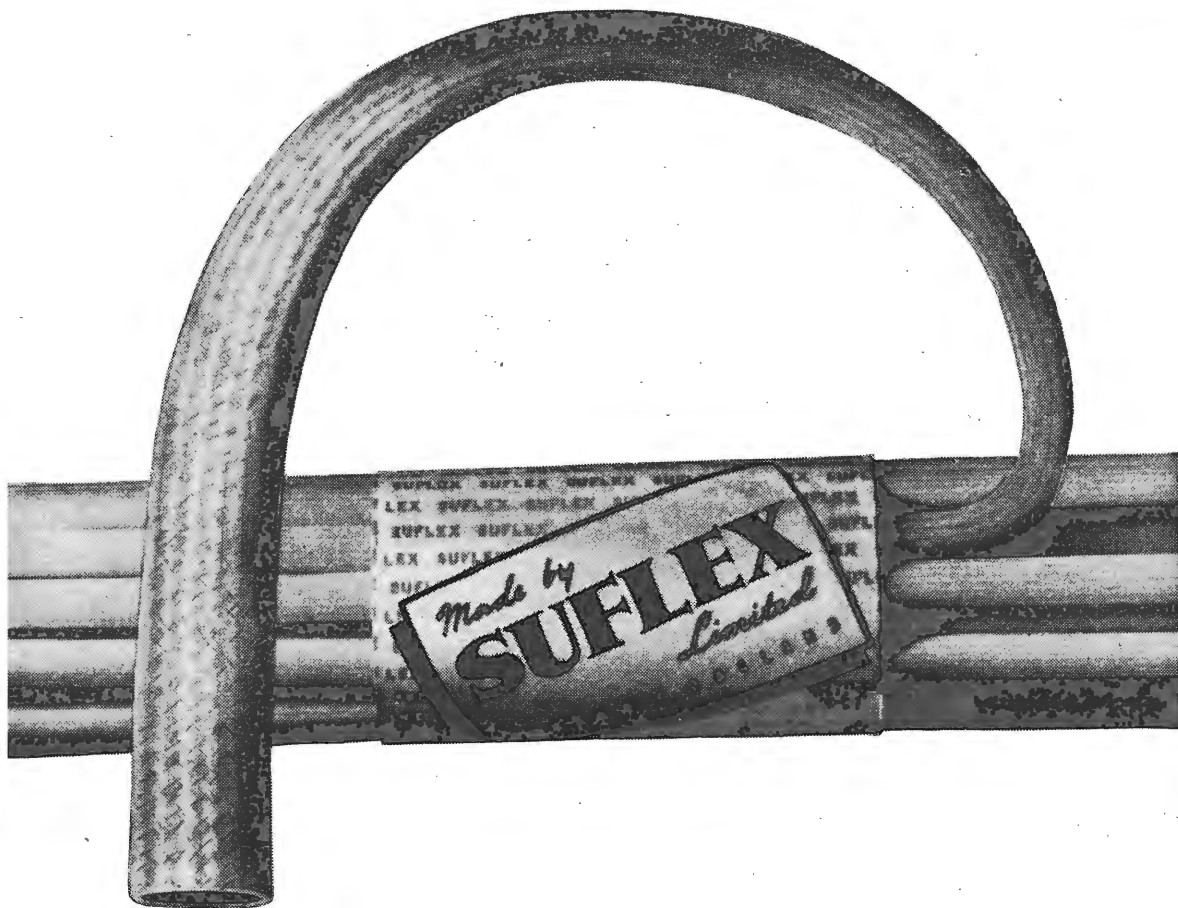

LIVE WIRES IN INSULATION

SUFLEX INSULATING SLEEVING

Insulation in some form is essential to all electrical circuits. We suggest you consider the Suflex range of sleeving, particularly those materials produced on a braided fabric base with their enhanced mechanical strength and resistance to both heat shock and impregnation cycles. If chosen wisely the sleeving can be relied upon for very dependable operation. In particular Periglas PVC Insulated Glass Sleeving (illustrated right) is just such an example of supreme quality. It is characterised by a Class B temperature category (130°C), 5,000 volt dielectric strength and unprecedented resistance to mechanical abuse. All Suflex Sleeving is as good for its particular task as is Periglas, one of the Suflex range.

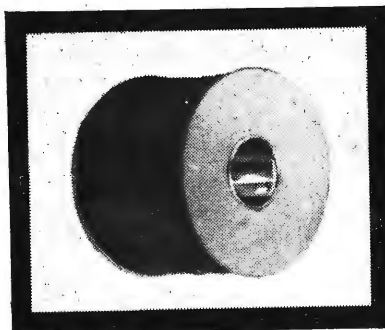

SUFLEX LTD., BILTON HOUSE,
EALING, LONDON, W.5

54 UXBRIDGE ROAD,
Telephone: EALing 7733

Bastable

LETTERS TO THE EDITOR

The Editor does not necessarily endorse the opinions expressed by his correspondents

Transistor Circuit Conventions

HAVING spent some considerable time in the last few years in the arduous but stimulating process of transistorizing myself, I have been continuously reminded of the helpful part which can be played by good notation. I therefore feel reasonably qualified and certainly strongly urged to weigh in with some contributions to your discussion.

Your editorial in the February issue of *Wireless World* expounds an admirable philosophy, though I am a little puzzled why you should apply this to transistor notation and not circuit convention in general, since your "loop and bottle" convention can certainly be described as "having had its origin in the past and having ignored the passage of time."

On the question of notation for transistors *per se*, I feel that the two conventions which you discuss, viz



are so nearly alike as to be equally explicit to any reader and hence acceptable almost interchangeably. I have previously expressed the view that principles rather than rigid rules are the requirement and I fully support your open verdict on this question. However, "he who falls down a pit while searching the heavens for a sign . . ."; and it appears to me that on page 70 (February), while discussing the fine points of two alternative conventions, you have ruined *both* by the inclusion of a superfluous and non-information-bearing "envelope". The ensuing discussion by "Cathode Ray" (who commands my greatest respect) verges on the ridiculous. But what is ridiculous is the envelope.

As regards "positive upwards", Baxandall argues strongly in favour of this. I believe him to be wrong, but must admit that the issue is largely one of personal taste. The convention which I have worked round to I would describe, with common sense rather than with rigour, as "Ground low, Rail high", "Rail" being that which feeds the collectors. It does not matter in the least whether the Rail is positive (n-p-n) or negative (p-n-p). With Baxandall I like to imagine the circuit diagram as carrying a voltage scale alongside it on which voltage excursions can be mapped. If we describe these excursions as "up, i.e. towards Rail" or "down, i.e. towards Ground" then we do not have to use the term positive and negative and the absolute polarity does not matter. In any case one should not be too d.c. minded; for most purposes both Rails are Ground in the a.c. sense. Further, in some cases I would have no hesitation in putting Earth on what I have previously been regarding as Rail.

I am advocating this system as one which I have personally found very useful despite the fact that it makes certain transistor circuits look extraordinarily like valve circuits, while in fact they have to be thought of very differently. We have all been taught to think of transistors as current-operated devices; but do we always do it? An amplifier of cascaded grounded-emitter stages is a good test case. Here one has to think almost exclusively in terms of *current* gain, and to a first approxi-

mation each collector current flows straight into the next base subject only to current losses due to shunting effects of the collector feed and base biasing networks.

Finally, some of your contributors admit to or complain about the redrawing of circuits. In my opinion this should be compulsory, since I believe that no one can fully grasp a circuit without personally drawing it. Better still, then go and make it!

Luton.

L. H. BEDFORD.

A SCHOOL of circuit-drawing ignored by your contributor Mr. P. J. Baxandall (*Wireless World*, January, 1962), possibly because it has few adherents in the United Kingdom, advocates that *all* power lines and returns should be assembled at the bottom of the diagram. In these days of mixed p-n-p and n-p-n transistor circuits, I believe that this is the only *logical* thing to do. Without offending the devotees of "collectors uppermost," the method can retain, though perhaps not to the same degree, the advantages of Mr. Baxandall's "positive uppermost" rule.

Admittedly an increase in the number of crossing conductors is almost inevitable, but these are scarcely obscurantist and are counterbalanced by other benefits. Signal paths can be conveniently swept clean of inter-stage isolating filters, bias networks, and bric-à-brac of that nature. The not-so-bright are reminded that a.c.-wise all power lines can usually be regarded as earthed returns. Even the Holford method of bypassing emitter resistors is made to look familiar!

Edinburgh.

H. H. BUSH.

SURELY Mr. Baxandall exaggerates the importance of the polarity of the h.t. supply in suggesting, as he does in the January issue, that a circuit including a p-n-p transistor should be drawn upside down compared with the equivalent circuit containing an n-p-n transistor or valve. Such a system causes unnecessary difficulty in reading circuit diagrams. For example, a resistor drawn above a transistor symbol may be a collector load if the transistor is an n-p-n type but an emitter load if it is a p-n-p type. Careful examination of the diagram is thus necessary to confirm the orientation of the transistor symbol. No such confusion is possible in the "collector uppermost" system.

Mr. Baxandall claims that his system facilitates the understanding of pulse circuits but there is no difficulty in tracing the passage of a signal through the various stages of electronic equipment provided one remembers simple rules, e.g., that there is phase inversion in a common-emitter stage but not in common-base or common-collector stages. These rules are independent of the polarity of the h.t. supply and apply to transistor circuits with a negative h.t. supply as well as to valve circuits with a positive supply. Indeed, equivalent valve and transistor circuit diagrams should, as far as possible, have the same layout to facilitate circuit recognition. Circuit diagrams are read by recognizing the patterns for certain commonly encountered arrangements such as those for RC-coupled amplifiers, blocking oscillators, etc., and it is a great help to the reader if each common arrangement is always drawn with the same basic layout no matter whether the active element is a transistor, a valve or any other type of active 3-terminal network. The adoption of such standard layouts makes for maximum clarity of presentation which is the principal aim of any circuit diagram. In Mr. Baxandall's system there

are two standard layouts for every circuit arrangement, one of which is inverted with respect to the other. This gives the students twice as much work to do in memorizing the layouts and introduces a considerable element of confusion, one example of which was mentioned above.

This subject is at present under active discussion by the British Standards Institution which will doubtless issue some relevant recommendations in due course.

Mr. Baxandall offers a challenge to the "collectors-uppermost" proponents concerning his Figure 10 and we are glad to accept this challenge. We should re-draw his Figure 10 (reproduced in the accompanying Fig. A) as in Fig. B and would show the emitter and collector voltage waveforms as in Fig. C. If this were included in a Technical Instruction we should add the following explanation.

"The blocking oscillator action of the p-n-p transistor (Fig. B) is controlled by the time constant CR. During the open-circuit period of the transistor capacitor C

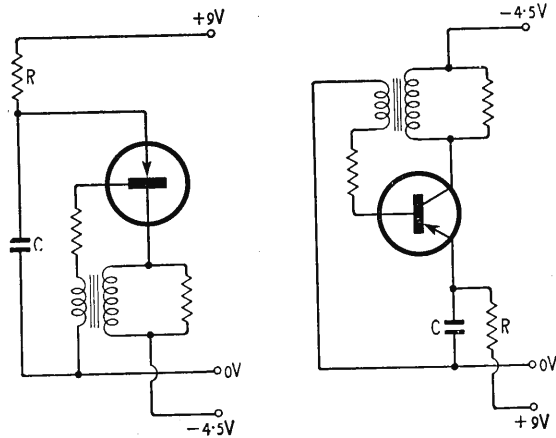

Fig. A.

Fig. B.

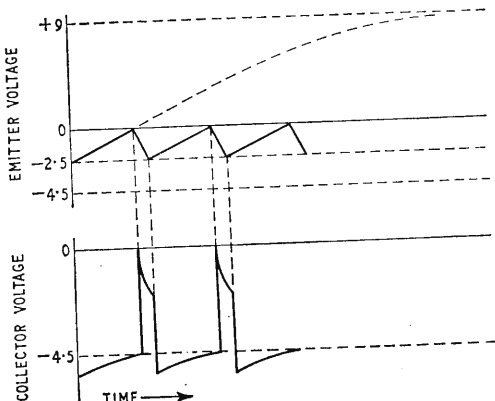

Fig. C.

charges towards +9 volts. However, when the voltage across C is slightly positive with respect to earth (making the base-emitter voltage slightly negative) the transistor conducts and C is discharged to a negative voltage dependent on the potential divider action of the collector load, transistor internal resistance and R. (This is given as -2.5 volts by Baxandall.) The transistor then open-circuits and C begins to charge again towards +9 volts. "The voltage on the collector is very nearly -4.5 volts

at the end of the charge period of C and it rises nearly to zero volts when the transistor short-circuits. During the discharge period of C the collector voltage falls to a value slightly above the emitter voltage, -2.5 volts. At this point the transistor open-circuits and the collector voltage falls, overshoots the -4.5 volts because of the inductance in the collector circuit and then discharges back to -4.5 volts."

We claim that a student, comparatively unfamiliar with transistor circuitry, would follow without difficulty our diagram and explanation.

London, W.1.

K. R. STURLEY.
S. W. AMOS.

Engineering Training Department,
British Broadcasting Corporation.

MR. BAXANDALL defeats his own case when he says that the opinions of the users, who "seldom have occasion to consider in much detail what happens inside the circuit blocks" should not be considered when standards are being set. Surely the whole purpose of a circuit diagram is to convey the function of the circuit to the user. Circuits are certainly not drawn for the benefit of designers.

The user is presented with a design *fait accompli*. His concern is not with the design difficulties but with rapid assimilation of a new circuit. Rapid assimilation is practical only if the circuit is so drawn that he can recognize circuit configurations quickly. Circuits drawn to the "collectors uppermost" convention always have the same configuration (Mr. Baxandall's Figs. 2, 3 and 4).

It is perfectly legitimate to look upon transistors as voltage-operated devices; they can be put in the same category as thermionic valves. The circuit reader need not concern himself whether valves, p-n-p or n-p-n transistors are used; the circuit configuration is the same for each and it is from this that he deduces the function of a circuit. The type of amplifying device is relatively unimportant and may be considered to be a 3-terminal device which has an amplifying function. No useful purpose is served by bogging the circuit reader down with transistor physics.

In tracing the passage of a signal through a circuit the polarity of the supply lines is quite irrelevant. Supply lines are at reference (earth) potential from a signal point of view. When a circuit reader sees a conventionally-connected amplifier stage he knows instantly that a positive-going input signal gives rise to a negative-going output signal regardless of the type of 3-terminal amplifying device used. When he sees a "cathode follower" type connection he knows that a positive-going input signal gives rise to a positive-going output signal. This facility of instant recognition is denied to the user of a "positive-uppermost" convention diagram. He must invert his thinking for p-n-p transistors and re-invert it for n-p-n transistors.

By virtue of the nature of the work he and his colleagues are doing, Mr. Baxandall may well have come to look upon the more awkward circuits as commonplace. He must recognize that the vast majority of the transistors produced today are soldered into conventional circuits in digital computers, radio receivers, stabilized power supplies and the like. We must not cloud this issue by looking at a small minority of awkward cases.

Mr. Baxandall quotes the "positive up-negative down" convention in graphical representation as an argument. I think most people prefer to think positively and the concept of quantities varying negatively is less easy to appreciate. Does Mr. Baxandall prefer his transistor characteristic curves in the third quadrant? Probably he does and I think this demonstrates that this whole subject is a matter of individual approach. I would certainly not seek to deny Mr. Baxandall's school their right to think negatively but he must also recognize the rights of those who wish to think positively.

I therefore strongly advocate that standardization on this question is not a practical proposition. It is up to the author of a circuit diagram to treat each case on its

merits bearing in mind first and foremost the needs of the ultimate user of the diagram.

One last point on transistor symbols. I agree with Mr. Baxandall's preference for symbol (a) in Fig. 1. Symbol (b) has, however, been agreed upon internationally at a recent meeting of the I.E.C. The British Standard will no doubt remain unchanged when it is republished. Since no alternative is or will be provided in B.S.530 in respect of transistor symbols, I submit that we must now recognize the B.S.530 transistor symbol whether we like it or not.

Wimbledon Park.

A. C. B. CAIN.

I WOULD like to comment on a few of the ideas put forward by Mr. Baxandall in his article in the January issue. As regards transistor symbols, the use of his Fig. 1(b) is so widely established that it is difficult to believe that any alternative will prove acceptable. My complaint about his Fig. 1(a) is that a totally different symbol would be required to indicate a tetrode whereas a straight continuation of the base line serves this purpose in (b). Moreover, (a) looks too much like a controlled rectifier, requiring merely the addition of a gate electrode on the collector side of the base line. There are so many semiconductor devices that it seems hopeless to devise symbols for them based either on functional properties or constructional details. How, for example, could one show on a diagram that a particular transistor was intended to operate in an avalanche mode? We are left then to choose some purely diagrammatic representation which is easy to draw, unambiguous in meaning and recognizable at sight. To my mind, the originators of new devices should give much more thought to this question since it is so difficult to make retrospective modifications. The situation is not new and it has a parallel in the field of nomenclature, particularly that associated with the fundamental particles of modern physics. If "A" discovers a negative particle and calls it an electron then "B" must take note of this when he finds its positive counterpart. After hearing gracious words like proton and neutron, what are we to think of a physicist who digs out a "hole"?

Turning now to the question of circuit diagrams of waveform generators, there is a great deal to be said for Mr. Baxandall's point of view that the most positive supply line should be drawn at the top, proceeding to the most negative at the bottom. I believe this convention should always be used when describing a new circuit, when drawing a waveform generator in isolation and, more generally, until every such circuit becomes an established unit, well known in the art. But when such circuits form minor elements in some more complex device the overriding need is for clear and simple draughtsmanship giving segregation of various functional blocks, involving the minimum number of crossing wires. The use of detached earth points is a useful device even if, in the text of the article, the author stresses the need for avoiding multiple earths.

When dealing with amplifiers, oscillators, modulators, demodulators and the whole paraphernalia of continuous wave manipulation I am in favour of a scheme which treats the circuits in the most logical way from the point of view of the signal and regardless of the polarity of the power supplies. Some years ago, particularly in America, it was standard practice to draw receivers and amplifiers with the h.t. feed, bias, a.g.c. and decoupling circuits below the earth line, leaving an uncluttered signal flow line above this datum. In some ways this was instructive. For example, considering RC amplifiers, it was easy to see which elements were effectively in parallel (e.g. the anode load and grid bias resistors). Bass lift due to inadequate decoupling, treble cut due to valve output capacitance, coupling capacitance to ground and valve input capacitance could easily be understood. The scheme made it easier to visualize the interstage phase shifts which might be expected. The idea lost its elegance and simplicity as soon as negative feedback, push-pull working, a.f.c. and a.g.c. caused

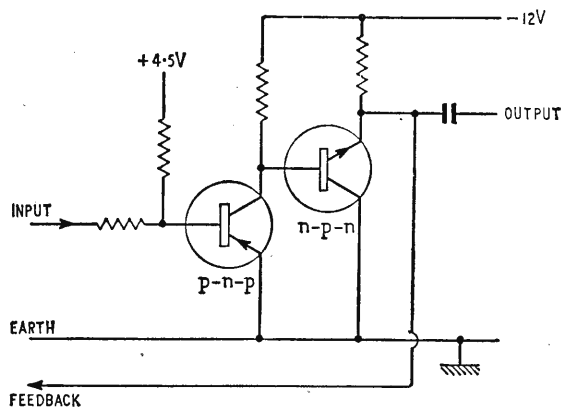

Fig. 1.

too much wiring to appear below the earth line.

In an oscillator, the points to be emphasized in the circuit diagram are the a.c. connections between the tuned circuit and the maintaining amplifier. The power supply connections, whether series or shunt feed, are of secondary importance. Similarly, in push-pull circuits, particularly those with complex feedback paths, it proves next to impossible to follow the "positive-upwards" rule.

Fig. 1 is my version of Figs. 6 and 7 in Mr. Baxandall's article. The only merit I claim concerns the simplicity of the drawing. My Fig. 2 is a re-draft of his Fig. 10, carried out with the same idea in mind. I find it reasonably easy to picture the waveforms in Fig. 2 but perhaps I have deluded myself by learning what to expect from a study of his arrangement! The n-p-n equivalent to Fig. 2 is given in Fig. 3.

To conclude, I have a profound respect for the circuit work carried out at R.R.E. by Mr. Baxandall and his colleagues. I recognize too that the quality of this work must owe a good deal to the soundness of the circuit conventions which have been adopted, which in

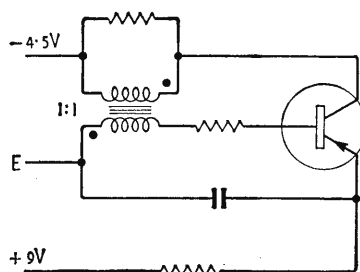

Fig. 2.

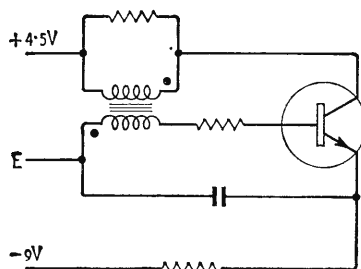

Fig. 3.

turn facilitate the understanding of known circuits and assist in suggesting new ones. In spite of this I feel that we should put up with his Fig. 1(b) as the preferred transistor symbol because of its world-wide acceptance. I think that in describing new waveform generators in isolation we might well adopt his convention of "positive-upwards," but that in complex circuits the aim should be overall simplicity of draughtsmanship. In continuous-wave devices the object should be to show a clear forward signal path. Supply voltage polarity conventions should be subordinated to this overriding requirement.

Cheltenham.

F. BUTLER

STANDARDIZATION of symbols is, I am sure *Wireless World* and all its readers will agree, a very desirable condition, and it is with this conviction that I am surprised to find *Wireless World* (February issue) joining a "splinter group," whose aim appears to be to alter the symbol recommended by B.S.I. for the transistor.

The allegation that the B.S.I. symbol represents a point-contact transistor is incorrect, because the point of its arrowhead does not reach the base, whereas that of the proposed alternative actually does (in the p-n-p version). The B.S.I. arrow indicates the direction of emitter current, and in that respect it is more consistent than is the alternative, whose arrow as shown must adopt a different position for p-n-p and n-p-n.

As has already been inferred, B.S.I. is not impervious to enlightened change, and it is as well to air the subject now if a change is sought. But once we upset an accepted standard, widespread confusion could easily occur, with a revival of several competitive patterns, that might last several years. Already *Wireless World* is at odds with a member of its own group, who considers the circle to represent a short-circuit; the late L. Bainbridge Bell considered it a gas-filled or evacuated envelope. And so *ad infinitum*.

I have no particular axe to grind, and I do not mind how I am to draw a transistor symbol, but I do object to changing an accepted practice without very good reason, and I hope that the present form of symbol as published in BS530 (Supplement 4) is continued.

Harrow.

E. A. W. SPREADBURY.

"Over the Hump"

I HAVE read your editorial comment (Dec. 1961) concerning the 60th anniversary of Marconi's first transatlantic radio transmission and Mr. Smith's subsequent letter on the same subject (Jan. 1962).

This transatlantic episode has been a controversial subject for the past three decades, and will probably remain so for ever. I have no doubt that Marconi was well aware that he must use the longest wave he was able to radiate efficiently if the test was to be successful. I do not believe, however, that Mr. Smith can be right when he suggests that the more likely frequency to have been used for the test was in the order of 45-50 kc/s (6,000 metres) where absorption in the D-region is small. We have it on the authority of Marconi's personal assistants—Vyvyan¹ and Solari²—that the wavelength used for the transatlantic test was "2,000 metres." I suggest that this is in keeping with the techniques of the day, for I do not think that in the year 1901 engineers had the necessary knowledge to design aerial systems capable of radiating long waves efficiently. In support of this statement I append a graph illustrating the progression to long waves for long-distance communication as described in the relevant literature by Vyvyan¹, Solari² and Fleming³. From this graph it would seem that 2,000 metres was about the longest wavelength which could have been achieved in 1901. It was not until 1907 that the frequencies mentioned by Mr. Smith were likely to have been used.

I agree with Mr. Smith to the extent that Marconi's reception of signals across the Atlantic in daylight cannot

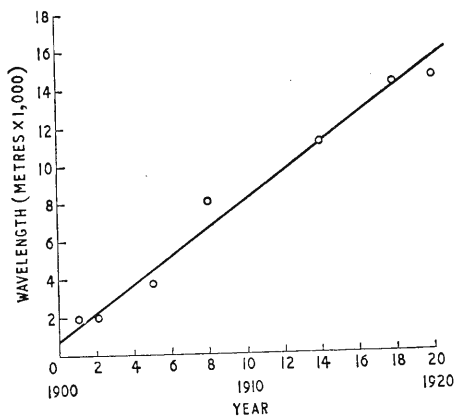

be fully explained by the "favourable" propagation conditions existing at that time as suggested in the editorial comment. The variation of propagation conditions in the long and medium wave bands, due to sunspot activity, is very small indeed, and I imagine it was probably one of the least of the practical difficulties—and one certainly unknown to Marconi—in his fight to communicate over great distances in the early 1900's. The 2,000-metre band, generally assumed to have been used by Marconi, suffers from the absorption which takes place in the D-region of the ionosphere during the hours of daylight, and Marconi's transatlantic signals, intercepted in daylight, must have suffered severely because of this. It is fortunate that he chose the month of December, when absorption is at a seasonal minimum, for the tests.

The signal/noise situation of the transatlantic tests does not seem to have received the consideration it deserves and it is interesting to note that, after making allowances for the difference between day and night absorption values on the one hand and the change in intensity of atmospheric noise on the other, it is likely that Marconi would have had a 10 dB signal/noise improvement had he delayed his experiment twelve hours.

Great Baddow, Essex.

G. A. ISTD,
Propagation Group,
Marconi Research Laboratories.

- ¹ Vyvyan, R. N. "Wireless Over Thirty Years." (George Routledge and Sons, London.)
² Solari, L. "Storia della Radio." (S. A. Fratelli Treves, Milano.)
³ Fleming, A. *Journal Royal Society Arts*. 1937, Vol. 86, No. 4436.

D.C. Restoration—the Overall Problem

IN an article appropriate to your journal, H. V. Sims deals with the purely technical considerations involved in "d.c. restoration and black level clamping" and it is perhaps unfortunate that more space could not be devoted to the subjective effect of attenuation or loss of d.c. component in the signal fed to the picture tube. In the article referred to (*W.W.*, January, 1962) it is shown that as far as the transmission chain is concerned, very great care is taken to see that the d.c. component is given due consideration and that the signal as transmitted has values appropriate to the brightness of the scene being viewed by the camera.

In receivers, however, this matter, mostly for reasons of an economic nature, is dealt with less successfully and the subjective result is not as satisfactory as it should be.

Consider a receiver with this failing that has been adjusted to give a satisfactory picture during the run of a programme which is just concluding. It is reasonable to

WIRELESS WORLD, MARCH 1962

assume that in the short period before the next programme starts, the screens at the transmitting source will be not only blank but black. Our receiver screen, however, will depict a degree of brightness intermediate between black and full brightness, namely grey. Suppose now that a caption consisting of a small amount of white lettering on a black background is transmitted. The effect on the receiver screen will be a slight darkening of the grey background and the lettering will be over-bright and perhaps show signs of the tube's inability to depict this degree of brightness.

At this point the viewer may adjust his brightness control so that the background is restored to black and at the same time the lettering will be shown at no more than maximum brightness, thus matching the picture at the transmitting source.

If now the caption is followed by a programme with a degree of average brightness similar to that of the preceding one, the viewer will find that his picture is too dark and that he has to readjust the brightness control to something like the original setting.

In his paper "The Importance of the D.C. Component" (*Journal of the Television Society*, June, 1953), Birkinshaw refers to this as "the long arm that reaches out from the transmitter and adjusts the receiver screen to the correct degree of brightness." However, the receiver discussed has made poor use of this facility and the viewer, if he is to have a satisfactory evening's viewing, will have to make this adjustment himself. The average viewer will not be aware of these failings beyond perhaps a vague feeling that the lighting is not consistently satisfactory.

Incorrect rendition of tonal values in a caption may not be very important but let us consider a programme of mainly average brightness which contains a scene where the desired effect is of a dimly lit figure moving about in a dark room. The Control Room monitors will correctly depict this as large areas of blackness with perhaps little points of light reflected from bright objects, but the receiver screen will show the black areas as grey, the bright points will be too bright and the general effect will be of a fog-bound atmosphere having no artistic appeal or dramatic quality.

Here again the viewer, should he be willing to do so, may turn down his brightness control and once again get the right sort of picture but he will have to repeat the process for each and every change in transmitted picture brightness during his period of viewing.

The "distortion of brightness values" can therefore have an important subjective effect on the viewer's appreciation of the programme and there will be those at the transmitting source whose efforts to convey a dramatic effect by brightness changes will be lost on the viewer to a degree depending on the poorness of the receiver.

Some efforts might be made to combat this situation by having available in the studio Control Rooms a monitor with less good d.c. characteristics, but the problem is complicated by the wide variations in the ability of different receivers to handle the d.c. component.

Chipstead, Surrey.

E. G. DANN.

Television Line Standards

THE suggestions put forward in what has been called the "I.T.A. plan" for changing to 625 lines seem totally devoid of imagination.

To assume that the adoption of a national 625 line system in ten years time will be any less a technical catastrophe than was the continuance of the 405 line system sixteen years ago shows lack of imagination and total disregard of the facts that even now exist.

Already the go ahead nations (television wise) are realizing the inadequacy of the 625 line systems with increasing screen dimensions. If, as it seems, we are destined to follow the rest of the world in the application of technical achievements to commercial fields let us

wait until the west Germans or the Japanese produce a system that is really worth changing to in ten years time.

Basildon, Essex.

T. J. BURKETT.

Negative Feedback and Power Output

IN AUGUST, 1961, you published a paper by Mr. S. W. Amos on which, late though it is, some comment must be made. I am not concerned with the slips of the pen (3dB loss does not mean half the current in the load); indeed I should be the last man to complain. I am very concerned about the attitude towards feedback which Mr. Amos has adopted.

Both "Cathode Ray" and I have shown in this and other market-places that for the description of the properties of negative feedback to be simple it must be used to make good amplifiers better. Mr. Amos will find that if he hopes to cut distortion from 10% to 1% with the usual tolerances on components, valves, supplies, he is going to have a rough time in the Test Room. One thousand amplifiers which meet a specification can be a pleasant sight: I would hate to see that number relying on feedback to get down from 10% to 1% distortion.

What has Mr. Amos done? He has taken an amplifier which would be 3dB down at 160c/s and might be regarded as giving a good performance down to, say, 320c/s, added negative feedback and hoped it would work at 50c/s. My guess, indeed, is that with the other response limiting components taken into account the feedback at 50c/s is positive. If the amplifier is to be used down to 50c/s, it is, quite simply, a 0.35W amplifier.

The two accompanying figures show the difference in design philosophy which can be encountered. If the

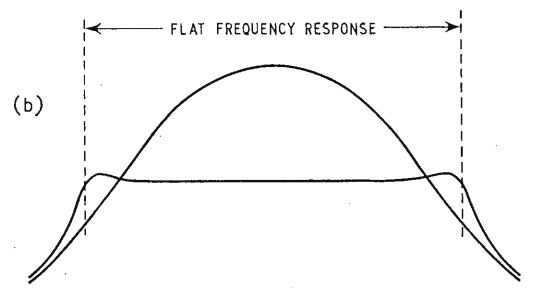
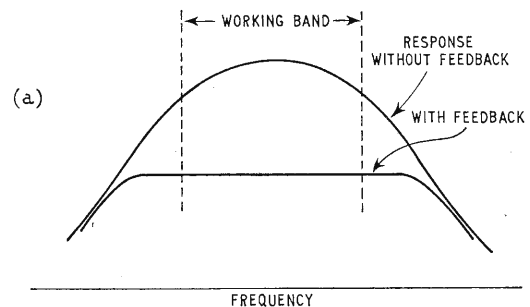

attitude exemplified by Fig. (a) is adopted Mr. Amos' problem hardly arises: the characteristic of Fig. (b) is one which appears to me to be opening the door to a fraudulent specification.

In practice, of course, Mr. Amos' bad transformer, and in his place I should ask for my money back, will itself be producing far too much distortion at 50c/s

anyway. There is only one sensible course of behaviour and that is to decide the pay-off balance between overload point and frequency response. Current feedback, from an undecoupled cathode resistor, will provide the wanted reduction in distortion at constant output current, leaving the response fixed by the output transformer. Voltage feedback will give a good low-level response with overload trouble. A mixture of the two will give a compromise. But whatever you do the valve will only produce so much current and if this is used as magnetizing current it cannot be used in the load.

But you cannot make a silk purse out of a sow's ear.

THOMAS RODDAM.

The Author replies:

I am grateful to Mr. Roddam for pointing out the slight technical error in my article but I think he has missed the main point. There has been a tendency among engineers to regard negative feedback as a universal method of correcting any deficiencies in equipment performance. Previous articles by "Cathode Ray" have shown that this is not so, and have pointed out that there are limitations to what can be done with feedback: my article was intended to extend this argument. Far from "hoping it would work at 50 c/s" as suggested by Mr. Roddam, I devoted some time in my article in showing why feedback could not help at 50 c/s.

The point is that feedback is a valuable tool but must be used with care, and I am sure Mr. Roddam would agree with this.

S. W. AMOS

Safety of Life at Sea

AS your correspondent, Mr. A. T. Ferguson, says, the prime purpose of radio apparatus aboard ship and at coast stations is safety of life, and the automatic action of an operator *should be* (a) to secure the message, and (b) to obtain a bearing.

Even if (b) proves unnecessary it may be the greatest value to guiding rescue craft to the position of the distress. There are no other methods available and it is wrong for anyone to imply that other systems exist which may make the shore stations obsolete and superfluous, as far as shipborne radio is concerned.

It is deplorable that Britain should surrender such services and abandon her proud and important role as watch tower in the fairway of world maritime interests.

Rather than discontinue such service it should be increased and extended by watch on the ever increasing traffic working on 1625-2850 kc/s, and the Coastguard Service might very well be incorporated.

The massive fixed D/F Stations could well give way to smaller and more numerous receivers working on ship-type frame aerials sited in suitable positions, but the frequency range of such equipment should cover both distress wavebands.

Bray.

A. A. TURNEY.

"Pipeless P.A. Pioneers"

WITH reference to "Free Grid's" remarks in the February issue, the idea of a microwave link for users of p.a. equipment on stages, etc., has been tried out a long time ago by various members of our Association and found excellent in its operation. Nearly two years ago we tried the Japanese transistor transmitter, the size of a packet of cigarettes, feeding into a receiver housed beside the p.a. amplifier. That works excellently; furthermore the cost of the equipment is very small indeed, under £50 complete.

Both B.B.C. and independent television have been and still are using radio microphones for years, e.g., "Sunday Night at the London Palladium." They work excel-

lently; very expensive; mostly made in Germany; cost around £200; work perfectly into good-quality p.a. equipment.

Now the snags. The Japanese product, most suitable and at the right price, uses a frequency that is already allocated to model boats, so that the G.P.O. cannot issue the necessary licence. At present no equipment is available in this country for which the G.P.O. will issue the necessary licence, and so it would look as if Southend will have to remain the same as everyone else and rely on making intelligent use of the p.a. system.

South Harrow.

ALEX. J. WALKER,

Hon. Secretary,

Association of Public Address Engineers.

Electronic Ignition

REFERRING to Mr. F. Butler's letter (Jan. issue) on the Lucas transistor ignition system, and his SCR alternative, he says the output current from his 100V, d.c. source doubled on substituting a spark plug for the $\frac{1}{8}$ in point gap. The average plug imposes a load in the order of 9 to 12pF. (cold) which, together with the higher impulse ratio, is doubtless responsible.

While it is doubtful if the cost of transistorized ignition or SCR alternatives is justified for purposes other than racing at present, a major advantage is the elimination of contact arm and cam with which timing can often be far from accurate. Any "play" in the top distributor bearing resulting from poor fit or wear can result in several degrees of error, and slight cam eccentricities or inaccuracies are almost bound to produce timing variations as between different cylinders. These are factors not to be tolerated on high-performance engines, though if kept within reasonable bounds they may be of small practical effect on run-of-the-mill productions.

Seven or eight years ago I designed a transistor system for a well-known racing engine of that period for replacement of coils which had proved inadequate, though in the outcome magnetos were made available before this was implemented. In this, timing was effected by a 3in commutator with narrow segments permitting resolution to within $\frac{1}{2}^\circ$, a maximum error which could be held constant irrespective of wear, etc. I would still recommend present experimenters to consider commutation timing of the very light control currents involved, because use could conveniently be made of existing distributor take-off gearing, and probably the automatic advance-retard feature as well, while timing adjustments would also be facilitated. The substitution of a commutator for the rocker arm and cam arrangement would be mainly a mechanical matter which could be performed on a spare interchangeable distributor at leisure.

Mr. Butler is doubtless aware that a $\frac{1}{8}$ in gap at atmospheric pressure is not an adequate criterion. Allowance must be made for a margin over that determined by the compression ratio of his car, which might be 8:1 or higher, and the correct plug gaps, the plug and cable plus distributor capacitance (say 150pF.), and for a minimum energy dissipation of the order of 0.004 Joule per spark at the gap. In general it is advisable to allow open-circuit voltages of about 15kV for plug gaps *circa* 0.025in and 20kV for gaps of 0.030in or more, though in practice, of course, the voltage demanded will vary with throttle opening, random impulse ratio, humidity, engine condition etc., and can be reduced by gap reduction. But to carry the latter too far can prove very unprofitable in terms of fuel consumption, easy starting, even pulling and tickover, and performance.

The average ignition coil primary inductance (12 to 15mH is common) tends to be excessive in the circuit proposed, having an adverse effect on the time constant, and revision of the d.c. voltage and/or main capacitor value suggested is indicated if adequate discharge energy for efficient combustion is to be assured.

Little Melton, Norwich.

J. R. C. MOORE.

NOW

YOU can MASTER ELECTRONICS!

BRITAIN'S MOST COMPREHENSIVE PRACTICAL COURSE in RADIO · ELECTRONICS · TELEVISION!

THESE SPECIAL TRAINING KITS — YOURS TO KEEP

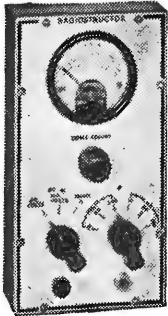

Multi - Range TEST METER



CATHODE RAY OSCILLOSCOPE

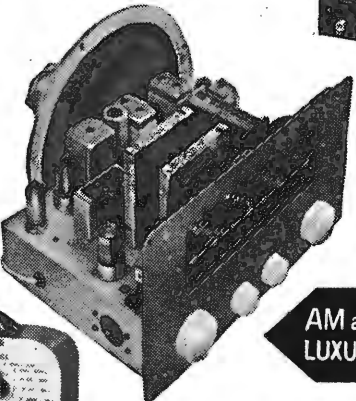

AM and VHF/FM LUXURY RECEIVER



SIGNAL GENERATOR



Complete set of Picture Way books and Experimental Manuals

LEARN BY BUILDING NOW for your CAREER · HOBBY · OWN BUSINESS

- YOU RECEIVE**
- Complete kits of equipment as illustrated.
 - Complete set of experimental manuals.
 - Complete set of 'picture way' theory books.
 - Modern test - yourself examination sheets.
 - Study programme.
 - Unlimited consultation with Tutors.

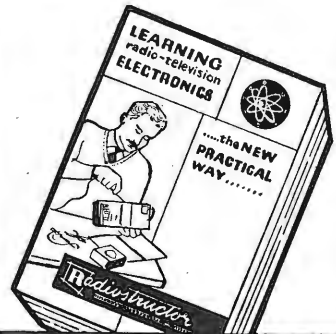

FREE BROCHURE NOW

RADIOSTRUCTOR

TO: RADIOSTRUCTOR (DEPT. M.66) READING, BERKS.

NAME

ADDRESS

(BLOCK CAPITALS PLEASE)

(We do not employ Representatives).

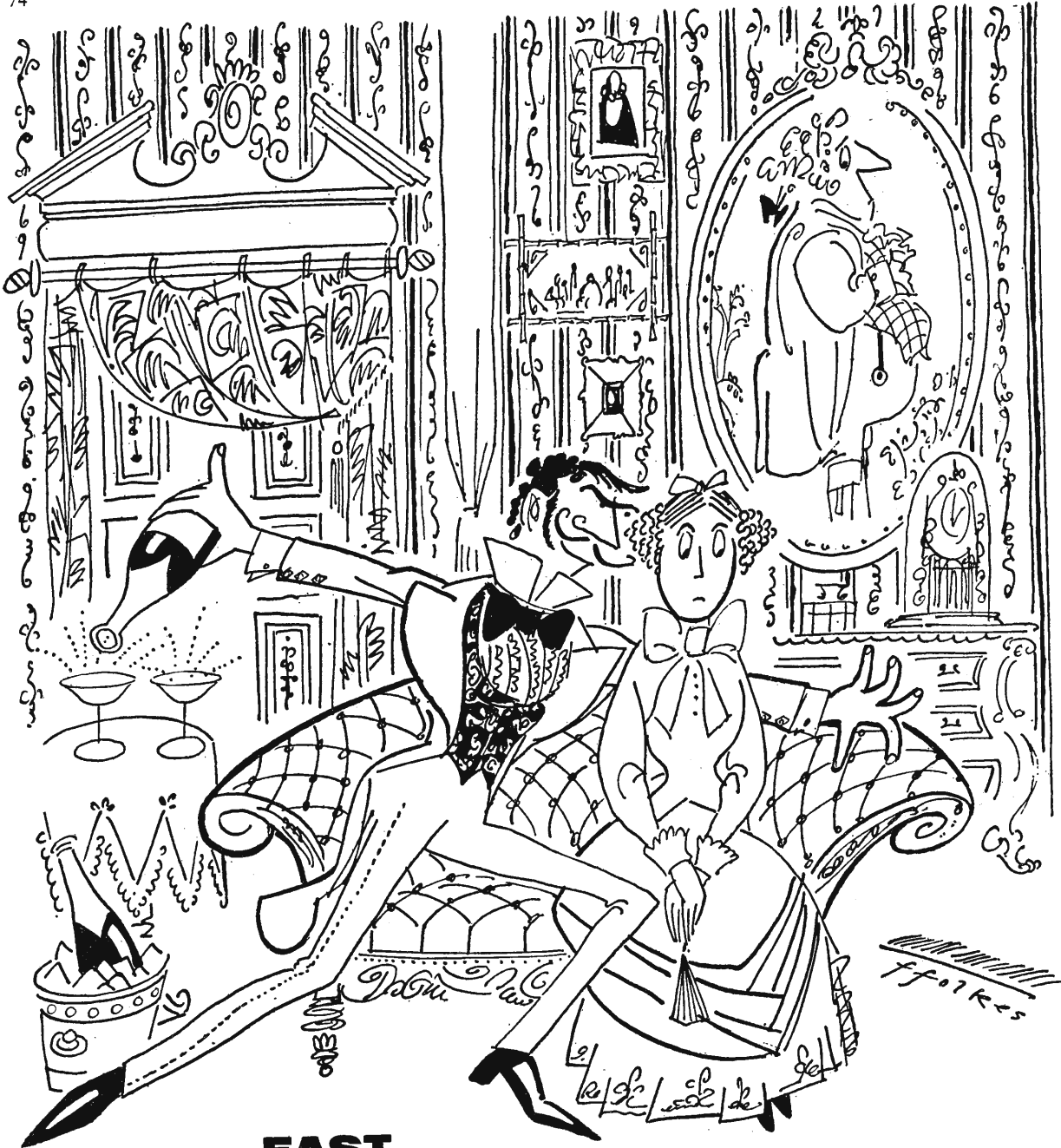

FAST OPERATOR GEX71 is a subminiature germanium gold-bonded diode with a very fast transient response, designed primarily for use in high speed switching circuits. Typical total recovered charge ($I_f=10\text{mA}$, $V_R=-5\text{V}$, pulse rise time $<2\text{ns}$) is 20pC

Write for details to **S.E.C. SEMICONDUCTORS**

THE GENERAL ELECTRIC COMPANY LIMITED · SEMICONDUCTOR DIVISION · BROADSTONE WORKS
REDDISH · STOCKPORT · CHESHIRE · (TELEPHONE: HEATON MOOR 6351)

METERS AND SENSES

By "CATHODE RAY"

FOR those who prefer long words, the title ought perhaps to be "Objective and Subjective Responses Compared." Wherever there is a discussion on measuring the quality of sound reproduction, someone is almost sure to say, "Well, of course, the ultimate decision rests with the human ear." So long as "ear" is understood to mean "mind, on the basis of responses received via the ears" that is true, but I doubt whether all those who nod their heads to this proposition are fully aware how totally different our human responses are from those of instruments. If they were, quite a lot of breath would be saved in arguments on a great variety of subjects, from whether or not it is a cold day to how much distortion is tolerable.

Perception of Sound

One of the main causes of the confusion is that words are used without clearly defined meanings. We have encountered an example already: "ear." It can mean the appendages at the sides of our heads, or the acoustico-electrical transducers just inside, or whatever it is in the brain that produces an impression when the impulses sent from them along the auditory nerves reach it, or the response of the brain to these impressions ("he plays by ear"), or a combination of these. Even the word "sound" is used sometimes to refer to a physical vibration of the air or other medium and sometimes to the mental impression produced very indirectly by that kind of sound—a vastly different thing. Then there is "colour"; is it a property of materials or a subjective impression?

Of course, one can get into very deep philosophical water over this. I don't want us to become involved in questions of whether or not the physical universe has any real existence apart from our consciousness of it. But we agree, presumably, that our whole knowledge of it is received through our senses. We tend therefore to assume the existence of a close relationship between the sensations we get in this way and their physical causes. Hence the use of words such as "sound" and "colour" to refer to both.

But there is absolutely no predictable relationship between the two things in any pair so named. If the whole human race had been blind, we might by use of our other senses have become just as knowledgeable about light in its physical or objective sense, but no amount of study of this would have given the slightest clue to the sort of sensation produced thereby in a being possessing the sense of sight. If you doubt this, try to explain the sensation of colour to a person born blind. (Or read H. G. Wells's "The Country of the Blind.") We have a well-developed science of radio waves, in spite of having no sense capable of responding to them directly. For all we know, there may exist beings possessing

such a sense, giving them sensations which to us are totally unimaginable.

It is hardly surprising, therefore, that trying to correlate the objective and subjective aspects of sound proves highly baffling, even when the distinction between the two is kept clear. They are so entirely different in nature.

We can measure various kinds of distortion by means of instruments without much difficulty. But so far, no one has been able to trace any inherent relationship between the instrument readings and the unpleasantness experienced by even average listeners (whoever they may be) who hear the distorted sounds. In general, the more distortion there is of a particular kind, other things being equal, the more unpleasant—or unreal—the reproduction sounds; but even that isn't universally true, and if it were it wouldn't get us very far, because of the restrictions (e.g., "... of a particular kind, other things being equal . . .").

Since the listener is the ultimate judge, one's natural instinct is to use him. The first problem is to find the "average listener." He (or she) bears no identifying marks or labels. So it is necessary to employ a sufficiently large sample of the population for there to be a reasonable probability that their average is close to the average for all listeners. If one wants to be able to make tests at any time one likes, this comes expensive, if indeed it is practicable at all in a period of full employment.

Conditioned Reactions

The next problem is that the answers the human "meters" give depend very much on whether these are fresh, or tired and want to go home, or whether they like or dislike the sort of sounds being heard, distortion apart. Another problem is that they don't have pointers moving over scales, and one can't be sure whether any numbers or descriptions they give are all in the same units. In fact, one can be pretty sure they are not.

Our "ultimate judge" having proved to be such an outstandingly unsatisfactory one, we naturally look again at instruments, which can be readily bought, ask for no wages, and give definite numerical readings. The one thing lacking is a generally-applicable relationship between such readings and the reactions of listeners. The search for this goes on at no small expenditure of time, money and effort.

One of the most determined quests was that carried out by a team in the B.B.C. Research Department under the direction of E. R. Wigan, who reported the main results in *Electronic Technology*, April and May, 1961. (A brief summary was given in *Wireless World*, December, 1961, p.611.) While an empirical formula was certainly extracted from the vast amount of experimental work, it was ad-

mitted to be not a complete solution to the problem.

That referred to non-linearity distortion. Some of the difficulties in tracing any consistent relationship between frequency response curves and listeners' preferences for the reproducers characterized by them were reviewed by M.G. Scroggie in the April 1961 issue. The outstanding feature in that connection is the persistent refusal of listeners to prefer what theoretically they ought to prefer—reproduction level over the whole audible range of frequency.

Loudness, Pitch and Timbre

But why are we starting with the complicated and notoriously intractable problem of distortion? The division between objective and subjective can be illustrated quite emphatically enough if we consider the most elementary characteristics of sounds—pitch, loudness and tone quality (or timbre). These are the subjective aspects—the sensations we get. It is still often supposed that they respectively correspond in a simple way to the objective characteristics of the physical sounds—frequency, intensity and harmonic structure. Very approximately, they do; but the influence of the other two characteristics on each of the three sensations is not always negligible, and is far from simple.

This was demonstrated nearly 30 years ago in a paper by Harvey Fletcher, "Loudness, Pitch and the Timbre of Musical Tones and their Relation to the Intensity, the Frequency and the Overtone Structure" (*Journal of the Acoustical Society of America*, Oct. 1934, pp. 59-69).

For example, the pitch and frequency of a musical note are often treated as almost interchangeable things. Yet the pitch depends on intensity and timbre as well as on frequency. Fig. 1 here is a copy of Fletcher's Fig. 8 in the paper just cited. It shows two surprising things: that pitch (to which most human listeners are sensitive to within a fraction of 1%) can be shifted as much as 10% by varying the intensity of the sound, and that this effect has a pronounced negative peak at 200 c/s. At 2000 c/s (where the ear is most sensitive to sound) it is nil, and above that frequency it is positive and relatively small.

At first this seems as if it would make nonsense of music. For instance, suppose a trombone is aiming at the conductor and is emitting air vibrations with a frequency of 196 c/s. According to British Standard 661:1955, this is G below middle C. But according to Fig. 1, at 80 phons (a possible loudness level in the circumstances), the pitch is 7% lower. This is more than a semitone flat, and is Sir Malcolm pleased? If he tells the trombonist to pull his slide in a bit to get into tune, the result will sound about a semitone sharp to a distant hearer.

Differences of about a quarter-tone would quite often arise, one would think, and be more excruciating still. So, highly sceptical about this phenomenon, I tuned my audio signal generator to 200 c/s, put on the headphones, and played about with the attenuator. The effect, on bringing up the sound from quiet to very loud, was most peculiar. You know those "optical illusion" pictures of a lot of cubes stacked together, which can appear either projecting outwards or hollowed inwards, according to how one happens to look at them first?

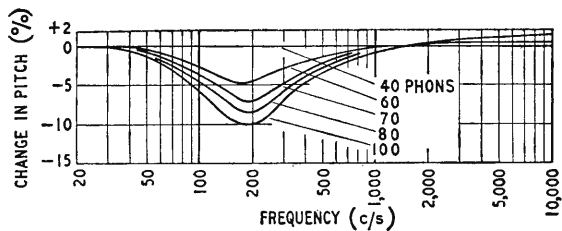

Fig. 1. Results of Harvey Fletcher's comparison between frequency and pitch. Here, pitch is reckoned in terms of frequency at a loudness level of 40 phons (i.e., at a sound intensity giving a loudness equal to that of a 1,000 c/s tone 40 dB above the normal threshold of hearing).

Quite an effort is required to change over from one to the other. Well, it was much the same with the sound. As I made it very loud, I could hear the pitch change either down or up. At that loudness there was, in fact, a sort of ambiguity of pitch that made it difficult for me to judge it.

Another thing that might seem as if it would go wrong if Fig. 1 were true was the relationship to other notes. Since the percentage shift at 200 c/s is much greater than at 400 c/s, what happens to the octave relationship? Surely that is rigidly fixed by the necessity for the higher note to make *exactly* two vibrations to every one of the lower? Fletcher thought of that one, and mentions an experiment to illustrate it. At 40 phons, which is fairly quiet, tone A and tone B, 200 c/s and 400 c/s respectively, and therefore an octave apart, *sounded* an octave apart, when played successively, and blended harmoniously when played together. Next, 100-phon notes, C and D, were adjusted to the same pitch as A and B respectively. Their frequencies turned out to be 222 c/s and 421 c/s, in agreement with Fig. 1. When played successively, they appeared to be an octave apart—though of course, on a frequency basis, they are not. *But when played together they sounded discordant.* Presumably—this was not stated—100-phon notes at 200 c/s and 400 c/s (or 222 and 444, or 210½ and 421), played together, would sound harmonious, notwithstanding that in succession they would not seem to be an octave apart.

This, then, is one example of how conclusions based on experiments with single pure tones are apt to break down when applied to more than one heard at a time. More familiar is the masking effect of one sound on another. As we know, a loud sound tends to make a weak one sound weaker or even altogether inaudible. The effect depends on the relative intensities and frequencies in very complicated ways, shown by Fletcher in his famous book "Speech and Hearing".

These masking effects apply even when the sounds heard together are in harmonic relationship to one another; i.e., when their frequencies are exact multiples of one (fundamental) frequency. So it is necessary to emphasize that Fig. 1 refers only to pure sine-wave sounds, and one can't apply the results of any such experiments to complex sounds. All musical instruments produce complex sounds, the harmonics sometimes being much stronger even than the fundamental; so Fig. 1 doesn't apply to music. Knowing the existence of the harmonics, one could pretty well guess this, for even if one of the fre-

quencies—the fundamental, say—happened to hit the downward peak, the large pitch-shift indicated there would presumably be “diluted” by the relative absence of shift at the harmonic frequencies. Incidentally, the hearing sense, being more sensitive to these higher frequencies, would almost certainly be disproportionately influenced by them.

Because of the unpredictability of relationships between objective and subjective—which is the main point of this whole treatise—such reasoning, though plausible, needs experimental confirmation. And broadly it gets it, for tests with musical instruments and other complex sounds disclose no appreciable pitch-shift effects. That, then, seems to be answer enough to our fears that the very foundations of music may be insecure.

But there are more answers. Fig. 2 shows the results obtained by W. B. Snow, also published in *J.A.S.A.* (July, 1936), quite soon after Fletcher’s. Here the negative peaks, up to 100 phons, are at 100 c/s or thereabouts, and only when the loudness level is above 110 phons does 200 c/s seem to come into the picture.

But before we waste any time arguing about that, let us come right up to date with the (at the time I’m writing) latest issue of *J.A.S.A.*, Oct., 1961. Here are recorded the results of extremely carefully and elaborately conducted experiments by A. Cohen to re-check the pitch-shift effect. Not only was no expense spared over the equipment, but two series

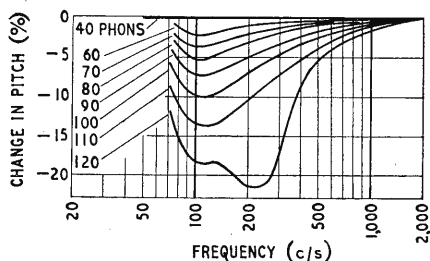

Fig. 2. W. B. Snow's results, for comparison with Fig. 1.

of tests were carried out, using different teams of young but highly trained musicians who were especially gifted in estimating pitch, and all the resources of modern statistical processing were brought to bear on the experimental results. In particular, deviations from a simple frequency/pitch ratio were compared with deviations as between one listener in the team and another, and between different results for the same comparisons, to try to disentangle a genuine intensity/pitch relationship from irrelevant variations.

Summing up, it appears that although there is a lowering of pitch with frequency in the 100-200 c/s region, and a raising of it at frequencies above 1,000-2,000 c/s, the average amount of this at the frequency where it is most marked is quite small—only 1-2%.

Before there is time for me to be hurried off to the scaffold for leading you up the garden so long with Figs. 1 and 2, I would like to point out that Cohen applied the sounds to one ear by means of an ear-phone, whereas Fletcher used a very high grade free-field system with loudspeakers. I for one would certainly not assume, without convincing evidence, that such presentations are equivalent for the

purpose. Unfortunately that point doesn't seem to have received much attention.

But it does all go to show how difficult it is to obtain reliable and consistent results in subjective tests.

That brings us to the question whether all the attempts to arrive at *scales* of sensation are not just wild goose chases. How far can sensation be regarded as quantitative?

Judging Loudness

Anyone who can hear them at all can decide which of two sounds is the louder, if they are suitably presented for comparison and differ only in intensity—even if the difference is quite small. But does it make sense to ask a hearer to say how many times one of the sounds is louder than the other? For one thing, the ratio of responses to the sounds conveyed along the auditory nerve to the brain must depend to some extent on the efficiency of the hearing mechanism in the individual listener, so even if the brain could give a scale reading it wouldn't necessarily be the same for all listeners. But assuming the listeners are selected to have hearing systems free from defects, and are of about the same age, should they be expected to measure loudness numerically?

I myself can attach no definite meaning to the statement that one sound is half as loud as another—even though that is the simplest ratio, used as the basis for most attempts to construct a scale of loudness. That may be because my mind is full of notions about sones and phons and dB and dynes per square centimetre. But I have other people who are undoubtedly free from this handicap, and they too are entirely lacking in confidence that they would recognize when a sound was half as loud. They tend, however, mistakenly of course, to assume that there is some definite half-way mark, which they would just lack the skill or experience to hit upon.

Still more unlikely, one would think, is the possibility of comparing *unlike* sounds numerically; for instance, low notes with high, or cello with flute. Nevertheless, a scale of loudness has been made, graduated in sones, and related to intensity and frequency. The relationships between this and “loudness level” (phons), “sensation level” (dB), etc., were described in “Loudness,” *W.W.*, Nov. 1957. But I would suggest that we don't allow ourselves to be unduly impressed by this appearance of objectivity that has been given to loudness. It is based, after all, on mere personal *opinions*, however carefully and systematically these have been collected. The results of different authorities differ numerically by as much as 10-20 dB. And so, in place of the familiar Fletcher-Munson curves, we have more recently been offered the Robinson-Dadson version of the same thing, which differs markedly (Fig. 3).

Yet loudness must be one of the least difficult sensations to measure. For practical purposes, the quality of unpleasantness or obtrusiveness may be even more important; e.g., in drafting laws to deal with road noises. Some members of the community would ascribe a high negative value to the unpleasantness of a well-tuned motor cycle exhaust and a high positive value to the rendering of a work by Schönberg; others would entirely reverse these assessments.

Coming back to pitch, we find that it, too, has

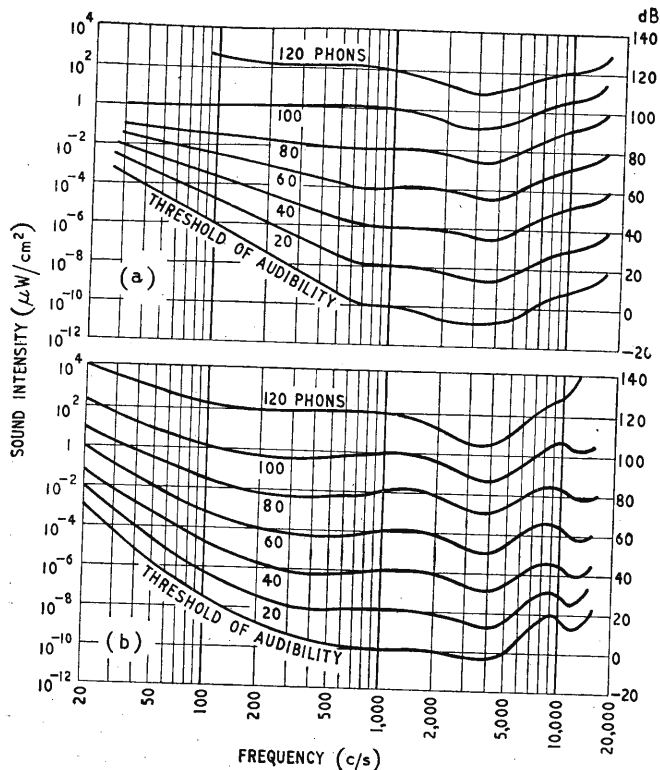

Fig. 3. (a) Fletcher-Munson and (b) Robinson-Dadson equal-loudness curves, illustrating the discrepancies between different experimenters' findings when subjective impressions are involved, even in a relatively simple way.

been fitted with a subjective scale, calibrated in mels (for melody!). How anyone sets about assigning a numerical value to the sensation of pitch, without reference to musical scales, which are based on the objective property of frequency, I just don't know. As with loudness, part of my trouble is what I do know. It is impossible for me to forget that a pure tone having twice the frequency of another blends with it in a particularly intimate way, producing a distinctive sensation which is destroyed by even a slight divergence from the 2:1 frequency ratio. This particular sensation corresponds precisely with that numerical frequency ratio, so if—against my better judgment—I am pressed into assigning a pitch ratio to the two tones it can hardly be other than 2:1. Even if the tones are sounded successively instead of together, I still mentally judge them as a musical octave, rather than purely as pitch—which, as I said, has no inherent numerical significance whatever for me. If I didn't happen to know that the sort of pitch we call high is produced by the source vibrating more times per second than when its pitch is called low, I might not even give it the larger number. (After all, one might as logically be guided by wavelength!)

As the ratio between the two alternately sounded notes is varied from 2:1 down to, say, 1:1, my sensations due to this ratio—presumably my sensation of pitch—doesn't change in a continuous way, but periodically assumes special significance whenever it corresponds with a musical interval.

I would admit that pitch and frequency don't

always seem to correspond exactly—for example, in my experiments with the audio generator—but the basis for my ability to notice such effect is still the musical scale.

The mel scale, however, has been made on the basis of a standard loudness level—usually 40 phons—at which the pitch-shift effect, if any, is taken as nil. Fig. 4 shows such a scale (this one was actually measured at 60 phons) due to S. S. Stevens, J. Volkman and E. B. Newman (*J.A.S.A.*, January, 1937). It departs quite significantly from a one-to-one relationship with frequency, although at 1,000 c/s the two scales are arbitrarily made to coincide, so reasonable agreement must have existed among the listeners whose estimates were obtained for the purpose. In the book "Hearing" by S. S. Stevens and H. Davis, the following explanation is given (p. 79): "The five observers who took part in the experiment showed consistency in their judgments, even though some of them had previously made the statement that pitch is not the sort of thing they would be able to cut in half. The judgment is apparently easier than one might suppose, especially if the observer does not become confused by the recognition of musical intervals." To which I would remark that although I am not a musician I can't imagine a sense of pitch that in an experiment of this kind could fail to be "confused" by the recognition of musical intervals. I understand there are "tone deaf" people who find no significance in musical intervals, and I should have thought—but may be wrong—that such people would be useless for

measuring pitch anyway. Even if they turned out to be the only ones fitted for this purpose (because unconfused by music) their findings would hardly seem to be of much value for general application.

So I remain in a mood of profound scepticism, from which I invite readers to rescue me.

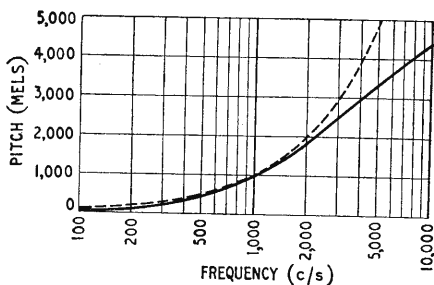

Fig. 4. "Measured" relationship between frequency and pitch. How much reliance can be placed on such a curve?

Most of this discussion has been about hearing. Perhaps, in this hey-day of television, I should have given more space to seeing. Though less informed on this subject, I do know that one's judgment of colour depends greatly on what it is compared with. Turquoise, compared with blue, looks green, and compared with green looks blue. This is rather like the well-known experiment to show how unreliable human beings are as thermometers. A bowl

(Continued on page 143)

of luke-warm water feels hot and cold at the same time, if one hand immersed therein has just been taken out of cold water and the other out of hot. But even without selective comparison, the unreliability remains. Our impression of hotness and coldness does not correspond at all exactly with temperature. It depends very much on humidity and other things. So it is really futile feeling annoyed with somebody who insists that it is warm when you are sure it is cold, or vice versa.

We would become nicer people to live with if we took more care not to confuse subjective impressions with objective qualities on the one hand or perverse imagination on the other. And if you are wondering what this motto has to do with *Wireless World*, I would point out that communications is a technology in which objective equipment is devised to produce subjective impressions, so it is desirable for practitioners therein to know how they are related.

BOOKS RECEIVED

Electronics, by Paul M. Chirlian and Armen H. Zemanian. A study of the working of electronic devices (valves and semiconductors). The authors employ the concept of a general three-terminal network to cover both valves and transistors as far as is possible, although the dissimilar features of each are treated separately. Equivalent circuits are developed for the devices discussed. Pp. 335; Figs. 246. McGraw-Hill Publishing Co. Ltd., McGraw-Hill House, 95 Farringdon Street, London, E.C.4. Price 68s.

Noise in Electronic Devices. A collection of material presented at a conference held by the Electronics Group of the Institute of Physics. Subjects discussed range from the physical basis of noise, noise in valves, transistors and microwave devices, to the behaviour of cracked carbon resistors and fluctuations in valve characteristics. Pp. 100; Figs. 48. Chapman and Hall, Ltd., 37, Essex Street, London, W.C.2. Price 35s.

Handbook of Preferred Circuits for Navy Aeronautical Electronic Equipment (Supplement No. 3). This addition to the handbook, which lists circuit "blocks" such as stabilizers, and/or gates etc. whose reliability has been proved in the field, contains a list of modifications to existing data (to use more recent transistor types for instance) and embodies additional circuits, the majority of which use transistors and are designed for computer and control purposes.

Prepared by National Bureau of Standards Department of Commerce for Bureau of Naval Weapons Department of the Navy and published by the U.S.

Government Printing Office, Washington 25, D.C., U.S.A., price 55 cents.

The original handbook (NAVAER 16-1-519) is in its third impression and costs \$1.75 and Supplements No. 1 and 2 are 60 cents and 30 cents respectively.

High-frequency Magnetic Materials, by W. J. Polydoroff. The development of magnetic materials from the early dust-iron cores to the modern ferrite is discussed, with attention to methods of characteristic measurement. Ferrites and applications of these materials are described, the last chapter being a discussion of the use of ferrites in microwave techniques. Pp. 220; Figs. 109. John Wiley & Sons Ltd., Gordon House, Greencoat Place, S.W.1. Price 72s.

TV Trouble Analysis, by Harry Mileaf. Logical fault finding for the serviceman. The theory of receiver operation is given, and then an explanation of how circuit faults can produce a variety of symptoms. The construction of components is discussed, and the reasons for possible failure. Pp. 224; Figs. 180. Gernsback Library, Inc., 154, West 14th Street, New York 11, N.Y. Price \$3.20.

Untersuchungen über Frequenz stabilization im Mikrowellengebiet by Dr. Sc. Techn. Alexander Brändli. Discusses methods of investigating the frequency stability of microwave generators, using a cavity resonator as a reference. Describes the equipment required and the technique of measurement. Pp. 51; Figs. 37. Verlag Leeman, Arbenzstrasse 20, Postfach, Zurich 34, Switzerland. Price 5 Swiss Francs.

SHORT-WAVE CONDITIONS

Prediction for March

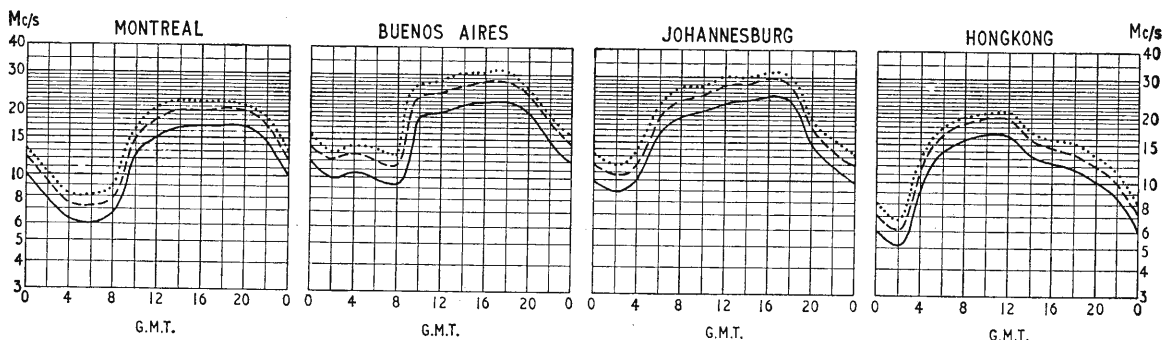

THE full-line curves indicate the highest frequencies likely to be usable at any time of the day or night for reliable communications over four long-distance paths from this country during March.

Broken-line curves give the highest frequencies that will sustain a partial service throughout the same period.

- FREQUENCY BELOW WHICH COMMUNICATION SHOULD BE POSSIBLE FOR 25% OF THE TOTAL TIME
- PREDICTED MEDIAN STANDARD MAXIMUM USABLE FREQUENCY
- FREQUENCY BELOW WHICH COMMUNICATION SHOULD BE POSSIBLE ON ALL UNDISTURBED DAYS

FUNDAMENTALS OF FEEDBACK DESIGN

3. — SIMPLE RESPONSE CHARACTERISTICS

By G. EDWIN

THE method which we shall adopt for studying feedback systems, indeed the method which we must adopt, is based on the combination of the relatively simple individual circuit responses. This method has certain limitations which in practice seem to affect only the most sophisticated designs: these limitations will be discussed very briefly in order to disarm the critics rather than to suggest that the reader should adopt the appropriate more elaborate design methods needed for formal accuracy.

We are concerned with systems made up of a chain of active elements interconnected by passive networks. Most commonly we have several valves or transistors coupled by capacitors and resistors or by transformers. The assumption we make is that the signal at the output electrode of an active device does not affect the input electrode. In practical terms this means that we do not take account of the anode-grid capacitance of a valve or the feedback resistance of a transistor. We can sometimes provide a first-order correction for these without in any way complicating the situation, but to take these factors fully into account would mean that the system would have multiple feedback loops all interacting. We shall see later what the effect of this can be.

It will be necessary to make use of Thévenin's Theorem and Norton's dual of it. Although these are discussed in most of the standard textbooks it may be as well to note the results here, because they are absolutely basic to what we are doing and bitter experience has shown that it is not difficult to avoid any knowledge of them. Let us suppose that we have a two-terminal black box which we know contains a linear active device. If the device is an amplifier we can include a unit signal input within the box. We are free to make any measurements we like at the two terminals. It can be shown that we need make only two measurements to specify the external behaviour of the box: there are instrumental reasons why we actually make far more but we shall see these in a moment.

The first measurement is of either the open-circuit voltage or the short-circuit current. This defines the activity, if we may misuse this word, of the contents of the box. The other measurement is of the impedance seen looking into the terminals, which we may want to describe as an admittance. Since this may be frequency dependent we shall probably need to make a number of data-observations to determine this impedance. We can now say that the external behaviour of the black box will be completely represented by either of the circuits shown in Fig. 9.

In a practical measurement we may have to make our calculations help us with our measurement. We could in theory measure E with the system open-circuited and then measure I with the system short-circuited and just calculate $Z_0 = E/I$ and $Y_0 = 1/E$. However, when we try to do this in practice we may find that the system is overloaded and that it becomes

non-linear. We can connect a load and vary it until the terminal voltage is halved, when the load is equal to Z_0 , but in many systems this, too, can lead to overloading. Sometimes we just change the load, keeping in the safe region; sometimes we make use of normal bridge measurement methods.

There are two quite separate reasons why this equivalent circuit pair should be kept in mind all the time. The first is that in almost all transistor circuits we are dealing with a finite and not too linear input impedance. The current fed into the input electrode, usually the base, is determined by the sum of the generator impedance and the transistor impedance, so that a high generator impedance will dilute the transistor non-linearity and reduce the distortion. When the current gain is fairly independent of current, this means that there is some economy of effort in thinking of the transistor as a current-operated device.

The second reason is connected with the behaviour of reactive networks. Suppose that we connect one or more reactances between our black box and a resistive load: even a single capacitor will do. At some instant the generator feeds energy into the

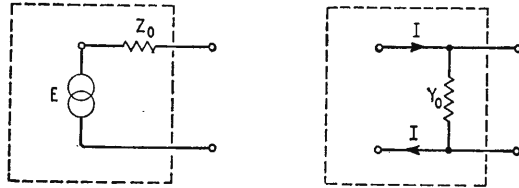

Fig. 9. Two alternative circuits representing the external behaviour of a two-terminal linear active network.

reactance: some may reach the load resistance immediately, but some is stored in some of the reactances. At later times the reactances begin to pay out the energy, usually with a lot of internal transfers in the process. There are two possible final homes, the load, and the internal resistance of the generator, the resistive part of Z_0 . The amount of energy which reaches the load thus depends on how much is handed back to Z_0 . A filter response depends on the source impedance just as much as it does on the load impedance. This internal to-ing and fro-ing of energy inside a reactive network is rather like the accounting operations of a large group of companies all paying each other for services and re-paying each other in dividends. The shareholder, who is the equivalent of the load resistor, may sometimes suspect that the equivalent network is a band-stop filter or that the internal elements have high dissipation (this is not a reference to expense accounts).

The need for a clear understanding is particularly exemplified by a practice, common in the thirties but now probably extinct, of the less reputable trans-

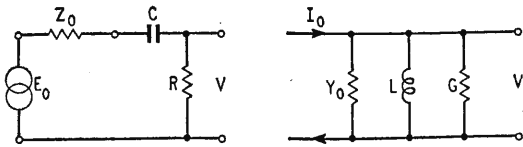

Fig. 10. Simple capacitance-resistance and inductance-resistance low-frequency coupling networks.

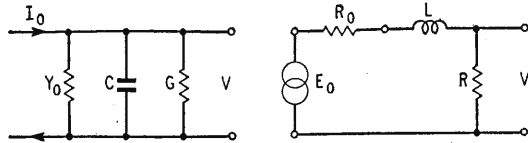

Fig. 11. Simple coupling networks (shunt capacitance and series inductance) which limit the high-frequency response of a system.

former makers (the adoption of this practice is itself a sign that a manufacturer is not reputable). They used to offer a response characteristic for their transformers measured with constant terminal voltage on the primary. This ingenious technique conceals the fact that there are not enough turns to give a decent operating low-frequency response and that by reducing the turns they have also managed to save on iron.

The most common coupling network, for we must now get down to the meat of the problem, is the simple capacitance-resistance network. The resistance will be taken to be the grid return resistance in a valve stage and is the resistance looking in to a transistor input electrode. Inductor or transformer coupling is also used, and at low frequencies these can be taken as equivalent. We may thus consider the two circuits shown in Fig. 10.

For the first circuit we have

$$\frac{E_0}{V} = \frac{R + Z_0 + 1/j\omega C}{R}$$

and if $Z_0 = R_0$, which is usually true in any simple practical situation,

$$\begin{aligned} \frac{E_0}{V} &= \left(1 + \frac{R_0}{R}\right) + \frac{1}{j\omega CR} \\ &= \left(1 + \frac{R_0}{R}\right) \left[1 + \frac{1}{j\omega C(R + R_0)}\right] \end{aligned}$$

For the second circuit we have

$$\begin{aligned} \frac{I_0}{V} &= Y_0 + \frac{1}{j\omega L} + G = \frac{1}{R_0} + \frac{1}{R} + \frac{1}{j\omega L} \\ &= \frac{R_0 + R}{R_0 R} \left[1 + \frac{1}{j\omega L} \left(\frac{R_0 + R}{R_0 R}\right)\right] \end{aligned}$$

First let us take $\omega \rightarrow \infty$, when we have

$$\frac{E_0}{V} = 1 + R_0/R = (R + R_0)/R = R_s/R$$

$$\text{and } \frac{I_0}{V} = \frac{R_0 + R}{R_0 R} = 1/R_p$$

where $R_s = R_0 + R$
and $1/R_p = Y_0 + G = (R_0 + R)/R_0 R$.

The terms in square brackets represent the frequency effect and are

$$\left[1 + \frac{1}{j\omega CR_s}\right] \text{ and } \left[1 + \frac{1}{j\omega L/R_p}\right]$$

and if we write $\omega_0 CR_s = 1$ and $\omega_0 L/R_p = 1$ in these two forms and then put $\omega_0/\omega = \Omega$ we get

$$[1 - j\Omega] \text{ and } [1 - j\Omega]$$

The substitutions have been chosen to lead us to this convenient form for both circuits. We shall leave these for a moment and turn to the other end of the spectrum.

There are two simple ways in which the upper end of a system frequency response may be limited. The commonest of these is the circuit shunt capacitance, but we must not overlook the effect of series inductance, usually the leakage inductance of a transformer. Very many transformer problems turn out to involve both capacitance and inductance and the whole transformer question can become extremely complex. At this stage we shall confine our attention to the two circuits shown in Fig. 11.

For the first of these we have

$$\frac{I_0}{V} = Y_0 + G + j\omega C = \frac{1}{R_p} \left[1 + j\omega CR_p\right]$$

and for the second

$$\frac{E_0}{V} = (R_0 + R + j\omega L)/R = \frac{R_s}{R} \left[1 + j\omega L/R_s\right]$$

Making, as before, the most suitable substitutions, which are

$$R_0 + R = R_s, Y_0 + G = 1/R_p, \omega_0 CR_p = 1, \omega_0 L/R_s = 1 \text{ and then taking } \omega/\omega_0 = \Omega$$

we get the terms in square brackets both reducing to the form

$$[1 + j\Omega]$$

We saw earlier that we should want to deal separately with the amplitude and phase response. We are confronted by a common form throughout if we combine the two forms as $[1 \pm j\Omega]$, and the amplitude response, referred to the region where $\Omega \rightarrow 0$, is just $20 \log(1 + \Omega^2)^{1/2}$ dB, while the phase is given by $\theta = \arctan \pm \Omega$.

These two expressions are for the ratio of input to output although normally we think in terms of output/input. This merely means that we must introduce minus signs to get

$$\begin{aligned} \text{amplitude characteristic} &= -20 \log(1 + \Omega^2)^{1/2} \text{ dB} \\ \text{phase characteristic} &= \arctan \mp \Omega \end{aligned}$$

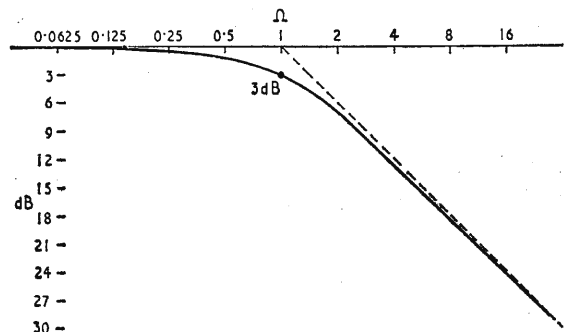

Fig. 12. Basic amplitude response characteristic of simple first-order network.

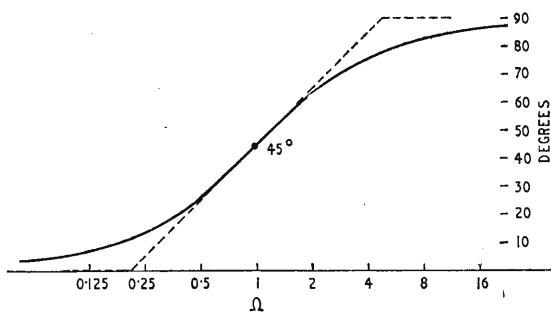

Fig. 13. Basic phase response characteristic of simple first-order network.

Looking back you will see that these shape characteristics depend for their critical frequency ω_0 on the combination, in either series or parallel, of the load resistance and the source resistance. This is why the concept of source resistance is so vitally important and why such stress was laid upon the need to keep constantly aware of the implications of Thévenin's Theorem.

The frequency characteristic is expressed in terms of a quantity Ω which is a normalized frequency. If we take first of all $\Omega = \omega/\omega_0 = \omega CR_p$, we can write

$$\begin{aligned} \log \Omega &= \log \omega - \log \omega_0 \\ &= \log \omega + \log CR_p \end{aligned}$$

We shall be using a logarithmic scale for Ω so we are quite justified in working with $\log(\text{frequency})$. We see that $\log \Omega = 0$, or $\Omega = 1$, when $\log \omega = \log \omega_0$, and that the effect of changing ω_0 is to shift the value of $\log \Omega$ sideways. The same result is obtained with $\Omega = \omega_0/\omega$, which gives

$$\log \Omega = \log \omega_0 - \log \omega$$

except that $\log \Omega$ now runs from right to left as ω runs from left to right. The two forms are thus mirror images of each other, a feature which in fact means that we can construct a template and simply turn it over to change from ω/ω_0 to ω_0/ω .

The shape is rather simple, too, and in quite a lot of problems has an even simpler approximation. At $\Omega = 1$ the amplitude characteristic is just 3dB down. At $\Omega \gg 1$ we can write

$$\begin{aligned} A &= -20 \log(\Omega^2)^{1/2} \text{ dB} \\ &= -20 \log \Omega \text{ dB} \end{aligned}$$

so that plotted against $\log \Omega$ the response is a straight line. When we double Ω we get an extra 6 dB of attenuation; when we increase Ω by a factor of 10 we get an extra 20dB. This basic slope of 6dB/octave or 20dB/decade is characteristic of simple first-order networks.

An amplifier design will involve the drawing of a number of frequency characteristics. Both for the sake of economy and also because log-linear graph paper seems to differ in size from manufacturer to manufacturer, it is found convenient to work either directly on a drafting pad or on ordinary squared graph paper. This is done by the simple process of thinking in octaves and as we have already seen, the amplitude characteristic approaches a straight line with a slope of 45° if we have equal scales for 6dB and for an octave. Using centimetric paper it is found that 3dB/cm and 2cm/octave gives the right sort of size for conventional amplifier designs with feedback in the region of 20-30dB. Larger plots

would use too much area for convenient filing; much smaller plots would not be accurate enough.

For the phase characteristic we need room for the 90° phase shift of a single section and the 180° limit of our whole system. Again we use 2 cm/octave and it is convenient to use 10°/cm for the phase. The basic responses are shown as Figs. 12 and 13. The straight line approximations shown provide all the information needed in a preliminary design, and with freehand correction if it is required in a particular region, will usually be as accurate as is justified by the tolerances on practical circuit elements. It would be possible to find a slightly closer approximation for the phase characteristic, but the one shown has the great advantage that it has a slope of 45° and is therefore very easily drawn.

Before we go on to apply these simple graphs to practical amplifier design we must deal with some other R-X circuits with only one kind of reactance which we meet in amplifiers. These will give us an opportunity of showing how easily the responses can be composed, both in the approximate and the exact form. We shall then be in a position to deal with everything inside the amplifier except possibly the transformers, which may behave as second order networks and may be even more awkward.

Commercial Literature

Spring "nuts" made by Simmonds Aeroaccessories under the name "Spire" are listed in great variety in a recent "Spire Speed Nut Manual" which is comprehensively indexed and cross-referenced. Dimensioned "blueprints" are given, as well as much useful general information. Copies from Simmonds Aeroaccessories Limited, 7 Cleveland Row, London, S.W.1.

Fuses are often regarded as something to put in circuit if one has time: the result of this lack of thought is often unsatisfactory performance, either as inadequate protection or annoying "inexplicable" blowing. "Notes on Fusing" (14pp), by G. F. Redgrave of Belling and Lee Ltd., is a valuable guide to the various types of fuses available, their performance and proper use. Belling and Lee Ltd., Gt. Cambridge Road, Enfield, Middlesex.

Travelling-wave Tubes: 40-page booklet from English Electric Valve Co. explains how they work; offers hints and tips on their use and lists abridged data on some E.E.V. types. English Electric Valve Co. Ltd., Chelmsford, England.

Q and its measurement by meter is dealt with in a 44-page booklet entitled "Measurements by Q meter" issued by Marconi Instruments Ltd. of St. Albans, Herts. The booklet also contains abridged operating and service notes for some Marconi Instruments equipments.

C.c. TV (closed-circuit television) equipment from Royston Industries' "Vistarama" range is described in a catalogue. "Vistarama" equipment can be used on 405-525- or 625-line systems and has 2.1 interlace. Full switching and control facilities are available. Royston Industries Ltd., Canada Road, Oyster Lane, Byfleet, Surrey.

Coaxial relays in the well-known "Londex" series are available for use on d.c. (or a.c. with a bridge rectifier but without smoothing). Power handling capacity 70W, s.w.r. low up to 200 Mc/s, Z₀ 45, 50 or 70Ω, variety of connectors. Type XCX has extra 50V 0.5A rated contact for other circuits. Leaflet from Londex Ltd. of Anerley Works, 207 Anerley Road, London, S.E.20.

Synchronous motor-driven timer, by Elremco, gives time cycles between 3sec and 24 hours. Switch rating is 5A at 250V a.c. and 24V d.c. and models are available for 50- or 60-c/s supplies. Leaflet from Electrical Remote Control Co., Ltd., Elremco Works, Harlow New Town, Essex.

Miniature soldering irons in the "Oryx" range are listed on a broadsheet from W. Greenwood Electronic Ltd., 677, Finchley Road, London, N.W.2.

CONFERENCES AND EXHIBITIONS

Further details are obtainable from the addresses in parentheses.

LONDON

- March 7 King's Head, Harrow
Public Address Exhibition
 (Assoc. of Public Address Engineers, 394 Northolt Road, South Harrow, Middx.)
- March 20-24 Earls Court
Electrical Engineers Exhibition
 (Assoc. of Supervising Electrical Engineers, 23 Bloomsbury Square, W.C.1)
- March 26-27 Imperial College
High Energy Nuclear Physics Symposium
 (Inst. of Physics & Phys. Soc., 47 Belgrave Square, S.W.1)
- April 17-18 Northampton College
Conference on Automatic Programming Languages
 (British Computer Society, Finsbury Court, E.C.2)
- April 23-May 2 Olympia and Earls Court
London International Engineering Exhibition
 (Industrial & Trade Fairs, Commonwealth House, New Oxford Street, W.C.1)
- April 26-29 Hotel Russell
Audio Festival & Fair
 (C. Rex-Hassan, 42 Manchester Street, W.1)
- April 30-May 5 Olympia
Production Exhibition & Conference
 (Production Exhibition, 11 Manchester Square, W.1)
- May 8-18 Earls Court
Mechanical Handling Exhibition
 (Mechanical Handling, Dorset House, Stamford Street, S.E.1)
- May 28-June 2 Olympia
Instruments, Electronics & Automation Exhibition
 (Industrial Exhibitions, 9 Argyll Street, W.1)
- May 31-June 7 Savoy Place
International Television Conference
 (I.E.E., Savoy Place, W.C.2)
- July 2-6 Imperial College
The Ionosphere
 (Inst. of Physics & Phys. Soc., 47 Belgrave Square, S.W.1)
- Aug. 22-Sept. 1 Earls Court
National Radio & Television Show
 (Radio Industry Exhibitions, 59 Russell Square, W.C.1)
- Sept. 19-21 Savoy Place
Components for Microwave Circuits
 (I.E.E., Savoy Place, W.C.2)
- Sept. 25-27 Imperial College
Neutron Beam Research in Solid State Physics
 (Inst. of Physics & Phys. Soc., 47 Belgrave Square, S.W.1)
- Oct. 18-19 Savoy Place
Symposium on Electronic Equipment Reliability
 (I.E.E., Savoy Place, W.C.2)

BOURNEMOUTH

- May 6-9 Norfolk Hotel
R.T.R.A. Conference
 (Radio & Television Retailers' Assoc., 19 Conway Street, London, W.1)
- Oct. 2-4 The Pavilion
Battery Symposium
 (D. H. Collins, Admiralty Engineering Laboratory, West Drayton, Middx.)

CARDIFF

- Sept. 4-7 The University
British Computer Society Conference
 (British Computer Society, Finsbury Pavement, London E.C.2)

CRANFIELD

- April 16-18 College of Aeronautics
International Flight Test Instrumentation Symposium
 (College of Aeronautics, Cranfield, Bucks.)

EXETER

- July 16-20 The University
Physics of Semiconductors
 (Inst. of Physics & Phys. Soc., 47 Belgrave Square, London, S.W.1)

FARNBOROUGH

- Sept. 3-9 R.A.E.
Farnborough Air Show
 (S.B.A.C., 29 King Street, London, S.W.1)

HARROGATE

- Sept. 20-22 Old Swan Hotel
Standardization in Non-destructive Testing
 (Institution of Production Engineers, 10 Chesterfield Street, London, W.1)

HARWELL

- Sept. 10-12 A.E.R.E.
Low Energy Nuclear Physics Conference
 (Inst. of Physics & Phys. Soc., 47 Belgrave Square, London, S.W.1)

MANCHESTER

- Sept. 19-28 Belle Vue
International Factory Equipment Exhibition
 (Industrial & Trade Fairs, Commonwealth House, New Oxford Street, London, W.C.1)

PEEBLES

- May 20-31 The Hydro
Scottish Radio Congress
 (Scottish Radio Retailers' Association, 4 Forres Street, Edinburgh, 3)

OVERSEAS

- March 26-29 New York
I.R.E. International Convention
 (I.R.E., 1 East 79 Street, New York, 21)
- April 10-14 Paris
International Conference on Stress Analysis
 (Joint British Committee for Stress Analysis, 1 Birdcage Walk, London, S.W.1)
- April 17-20 Los Angeles
Sector-focused Cyclotrons
 (Dr. B. T. Wright, University of California, Los Angeles)
- April 24-26 New York
Symposium on the Mathematical Theory of Automata
 (Polytechnic Institute of Brooklyn, 55 Johnson Street, Brooklyn 1, New York)
- April 28-May 5 Montreux
International Television Symposium & Exhibition
 (International TV Festival, P.O. Box 97, Montreux)
- April 29-May 4 Los Angeles
Colour Motion Pictures & Colour Television
 (Society of Motion Picture & Television Engineers, 55 West 42 Street, New York 36)
- April 29-May 8 Hanover
German Industries Fair
 (Schenkers Ltd., Royal London House, Finsbury Square, London, E.C.2)
- May 3-4 Long Beach, Cal.
Congress on Human Factors in Electronics
 (Dr. C. Hopkins, Hughes Aircraft Co., Culver City, Cal.)
- May 8-10 Washington
Electronic Components Conference
 (I.R.E., 1 East 79 Street, New York 21)
- May 14-16 Dayton
National Aerospace Electronics Conference
 (NAECON, 1414 E. Third Street, Dayton, Ohio)
- May 18-June 3 Stockholm
British Trade Fair
 (British Overseas Fairs, 21 Tothill Street, London, S.W.1)
- May 22-24 Chicago
Conference on Self-Organizing Systems
 (G. T. Jacobi, Armour Research Foundation, 10 West 35 Street, Chicago 16)
- May 22-24 Boulder
Microwave Theory and Techniques
 (I.R.E., 1 East 79 Street, New York 21)
- May 24-26 Seattle
Space Communications
 (I.R.E., 1 East 79 Street, New York, 21)
- May 27-June 11 Liege
Liege International Fair
 (R. C. Liebman, 178 Fleet Street, London, E.C.4)

(Continued on page 148)

- May 28-June 1 Paris
Seminar on Modern Methods of Computation & Industrial Automation
 (J. Hoffman, 50 av. Franklin D. Roosevelt, Brussels)
- June 18-19 Chicago
Broadcast & Television Receivers Conference
 (I.R.E., 1 East 79 Street, New York 21)
- June 25-27 Washington
Military Electronics Conference
 (I.R.E., 1 East 79 Street, New York 21)
- June 25-30 Copenhagen
Electromagnetic Theory & Antennas
 (J. Brown, Department of Electrical Engineering, University College, London)
- June 27-29 New York
Integrated Automatic Control Systems
 (A. J. Hornfeck, Bailey Meter Co., 1050 Ivanhoe Road, Cleveland 10, Ohio)
- Aug. 14-16 Boulder
Precision Electromagnetic Measurements Conference
 (J. F. Brockman, National Bureau of Standards, Boulder)
- Aug. 21-24 Los Angeles
Western Electronic Show
 (Wescon, 1435 S. La Cienega Blvd., Los Angeles, 35)
- Aug. 21-28 Copenhagen
International Congress on Acoustics
 (Professor S. Ingerslev, Royal Technical College, Ostervoldgade 10, Copenhagen)
- Aug. 27-Sept. 1 Munich
Information Processing & Digital Computers
 (International Federation of Information Processing Societies, c/o British Computer Society, Finsbury Court, London, E.C.2)
- Aug. 29-Sept. 1 Stockholm
Speech Communication Seminar
 (Dr. G. Fant, Royal Institute of Technology, Stockholm 70)
- Aug. 29-Sept. 5 Philadelphia
International Congress on Electron Microscopy
 (Prof. T. F. Anderson, Institute of Cancer Research, Philadelphia 11, Pa.)
- Sept. 3-7 The Hague
International Congress on Microwave Valves
 (Congres Microgolfbuizen, Postbus 62, Eindhoven)
- Sept. 3-7 Brussels
International Symposium on Information Theory
 (Dr. F. L. Stumpers, Philips Research Laboratories, Eindhoven)

MARCH MEETINGS

Tickets are required for some meetings; readers are advised, therefore, to communicate with the secretary of the society concerned.

LONDON

2nd. I.E.E.—Discussion on "Methods of measuring man's environment temperature" by Dr. R. H. Fox and C. R. Underwood at 6.0 at Savoy Place, W.C.2.

5th. Women's Engineering Society.—"Colour television" by P. S. Carnt at 7.0 at 45 Great Peter Street, S.W.1.

8th. Radar & Electronics Assoc.—"Video tape recording" by Dr. P. Axon at 7.0 at Royal Society of Arts, John Adam Street, Adelphi, W.C.2.

12th. I.E.E.—"The design and performance of transistor portable receivers" by Dr. A. J. Biggs at 5.30 at Savoy Place, W.C.2.

14th. Brit.I.R.E.—Papers on "Developments in c.w. position-fixing and navigation" at 6.0 at the School of Hygiene and Tropical Medicine, Keppel Street, W.C.1.

14th. Royal Society of Arts.—"The miniature wonders of transistors" by L. J. Davies at 6.0 at John Adam Street, Adelphi, W.C.2.

16th. Institute of Navigation.—"V.L.F. navigation" by H. F. Schwartz and L. C. Stenning at 5.30 at 10 Upper Belgrave Street, S.W.1.

16th. B.S.R.A.—"Modern studio sound equipment" by E. W. Berth Jones at 7.15 at Royal Society of Arts, John Adam Street, Adelphi, W.C.2.

20th. Inst. of Physics & Phys. Soc.—Annual General Meeting of Electronics Group, followed by "Semiconductor surfaces" by Dr. P. C. Banbury at 5.30 at 47 Belgrave Square, S.W.1.

21st. British Computer Society.—"The Atlas supervisor" by Dr. D. J. Howarth at 2.30 at Northampton College of Advanced Technology, St. John Street, E.C.1.

21st. I.E.E.—"Xerography" by Dr. A. T. Starr at 5.30 at Savoy Place, W.C.2.

22nd. Television Society.—"Television camera tube developments" by Dr. R. L. Beurle, W. E. Turk and D. A. Pay at 7.0 at Cinematograph Exhibitors' Association, 164 Shaftesbury Avenue, W.C.2.

26th. I.E.E.—Discussion on "Electronics or power as a future career?" opened by Professor M. G. Say at 6.0 at Savoy Place, W.C.2.

28th. Brit.I.R.E.—Symposium on "Practical electronic aids for the handicapped" at 2.0 at the School of Pharmacy, Brunswick Square, W.C.1.

28th. Royal Society of Arts.—"The electron microscope: past, present and future" by Dr. V. E. Cosslett at 6.0 at John Adam Street, Adelphi, W.C.2.

30th. R.S.G.B.—V.H.F. Symposium arranged by the London V.H.F. Group at 6.30 at the I.E.E., Savoy Place, W.C.2.

ARBORFIELD

26th. I.E.E. Graduate & Student Section.—"Principles and programming" by D. Rowley at 7.0 at School of Electronic Engineering.

BELFAST

13th. I.E.E.—"The characteristics and protection of semi-conductor rectifiers" by D. B. Corbyn and N. L. Potter at 6.30 at David Keir Building, Queen's University, Stranmillis Road.

22nd. I.E.E.—Faraday Lecture "Expanding horizons in communications" by D. A. Barron at 7.30 at Sir Wm. Whitla Hall, Queen's University.

BIRMINGHAM

22nd. Brit.I.R.E.—"Cryotrons" by Dr. P. R. Stuart at 6.15 at The University.

26th. I.E.E.—"The use of computers in process control applications" by J. F. Roth at 6.0 at the James Watt Memorial Institute.

BRISTOL

14th. Brit.I.R.E.—"Recent applications of and refinements in electronic digital computers" by Dr. A. D. Booth at 7.0 at the College of Science and Technology (Joint meeting with the British Computer Society).

CAMBRIDGE

19th. I.E.E.—"The application of electronics to the electricity supply in-

dustry" by Dr. J. S. Forrest at 6.30 at the College of Arts and Technology.

CARDIFF

7th. Brit.I.R.E.—"Transistors in transmitters and communications receivers" by A. J. Rees at 6.30 at the Welsh College of Advanced Technology.

CHATHAM

21st. I.E.E. Graduate & Student Section.—"Transistors v. valves" by A. W. Hart at 7.0 at Medway College of Technology, Maidstone Road.

CHELTENHAM

2nd. Brit.I.R.E.—"Modern transmitter techniques" by W. J. Morcom at 7.0 at the North Gloucestershire Technical College.

23rd. Society of Instrument Technology.—"Applications of ultrasonics in the processing field" by E. A. Neppiras at 7.30 at Belle Vue Hotel.

CRAWLEY

21st. I.E.E.—"Problems in electronic control of machine tools" by J. A. Stokes and M. Monk at 6.30 at Crawley Technical Institute.

EDINBURGH

6th. I.E.E.—"Women engineers in the U.S.S.R." by Miss R. Winslade at 7.0 at the Carlton Hotel, North Bridge.

7th. Brit.I.R.E.—"Carrier telephony" by J. L. Somerville at 7.0 at The University, Drummond Street.

FARNBOROUGH

20th. I.E.E.—"Air traffic control" by Dr. E. Eastwood and Dr. B. J. O'Kane at 6.15 at Farnborough Technical College, Boundary Road.

27th. Brit.I.R.E.—"Heads for magnetic tape recording" by E. C. Wildman at 7.0 at Farnborough Technical College.

GLASGOW

8th. Brit.I.R.E.—"Carrier telephony" by J. L. Somerville at 7.0 at the Institution of Engineers and Shipbuilders, 39 Elmbank Crescent.

29th. I.E.E.—Faraday Lecture "Expanding horizons in communications" by D. A. Barron at 6.0 at St. Andrews Hall.

LEICESTER

8th. Society of Instrument Technology. — "The English Electric 'Saturn' analogue computer" by Dr. T O. Jeffries at 7.30 at The University.

LIVERPOOL

1st. I.E.E.—Faraday Lecture "Expanding horizons in communications" by D. A. Barron at 6.30 at Philharmonic Hall.

8th. Society of Instrument Technology.—"The selection of electrical transducers" by J. W. Nichols at 7.0 at the Electricity Board Industrial Centre, Paradise Street.

21st. Brit.I.R.E.—"Video tape recording" by A. Harris at 7.30 at the Walker Art Gallery.

MALVERN

29th. Brit.I.R.E.—"Tunnel diodes" by Dr. G. D. Bergman at 7.0 at the Winter Gardens.

MANCHESTER

1st. Brit.I.R.E.—"A colour television projection for medium screen applications" by P. Lowrie at 7.0 at the Reynolds Hall, Manchester College of Science and Technology.

14th. I.E.E.—"Air traffic control" by Dr. E. Eastwood and Dr. B. J. O'Kane at 6.15 at the Engineers' Club, Albert Square.

19th. Inst. of Physics & Phys. Soc.—"Experiments in rockets and satellites" by J. A. Ratcliffe at 7.0 at The University.

MIDDLESBROUGH

7th. I.E.E.—"The banana-tube display system—a new approach to the display of colour television pictures" by Dr. P. Schagen at 6.30 at the Cleveland Scientific and Technical Institution.

NEWCASTLE-UPON-TYNE

14th. Brit.I.R.E.—"Performance and design considerations of high-gain d.c. amplifiers to be used in analogue computers" by Dr. A. E. Freeman at 6.0 at the Institute of Mining and Mechanical Engineers, Westgate Road.

19th. I.E.E.—"Satellite instrumentation" by Dr. R. L. F. Boyd at 6.30 at Rutherford College of Technology, Northumberland Road.

NOTTINGHAM

27th. I.E.E.—"Electroluminescence" by Dr. J. R. Acton at 6.30 at the Nottingham and District Technical College, Burton Street.

PORTSMOUTH

6th. Brit.I.R.E.—"Radar track indication" by L. R. Cathie at 7.0 at Portsmouth College of Technology.

21st. I.E.E.—"A review of some modern microwave valves" by Dr. D. G. Kiely at 6.30 at College of Technology, Park Road.

SOUTHAMPTON

13th. I.E.E.—"A tunnel diode storage system" by A. J. Cole at 6.30 at The University.

WOLVERHAMPTON

14th. Brit.I.R.E.—"Colour television — implications to service engineers" by J. N. McAinsh at 7.15 at the Wolverhampton College of Technology.

A



SIGNAL LAMP FOR EVERY PURPOSE

Millions of lives, every day, depend on the efficient functioning of warning signals; from the depths of the sea to the heights of the sky, from east to west, whether in the kitchen, factory, or office, people's safety must be assured.

The research and planning division at the House of Bulgin have over 35 years' experience in manufacturing Signal Lamps for industry, and produce the most compact and reliable range obtainable. For sheer brilliance of signal and choice of many sparkling lens colours, Bulgin Signal Lamps are unsurpassable.

Write now for a fully illustrated leaflet No. 1502/C which contains details of our complete range.

Also available, our comprehensive catalogue No. 202/C which illustrates, with full technical details, the complete range of over 10,000 Electronic Components manufactured by the House of Bulgin. Price 2/6 post free, or free to trade letterhead or order.

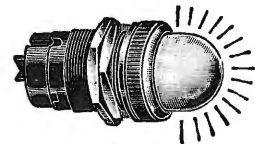

List No. D.690

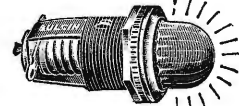

List No. D.785 & A.2149



List No. D.775/MQ

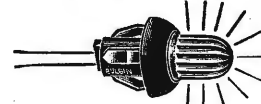

List No. D.815, 816

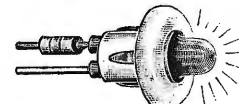

List No. D.808



List No. D.720

OVER 2,670 TYPES

A.F. BULGIN & CO. LTD.

BYE-PASS ROAD, BARKING, ESSEX.
Telephone: RIPPleway 5588 (12 lines)

UNBIASED

By "FREE GRID"

Mesmerized by Maths

THE exhibition staged by the Science Museum to commemorate Marconi's bridging of the Atlantic by wireless on December 12th, 1901, was of great interest, although small. But I found the all-too-frequent interruptions by Marconi's recorded voice describing his feat, to be very distracting, as it was audible all over the room. Surely the organizers could have cut out the loudspeaker, and have provided several telephone hand sets for those wanting to hear.

Since there seems to be some difference of opinion concerning Marconi's all-daylight feat with such primitive apparatus, I have often thought of going to Newfoundland myself, armed with a kite and the other necessary odds and ends. The trouble is that there are no spark

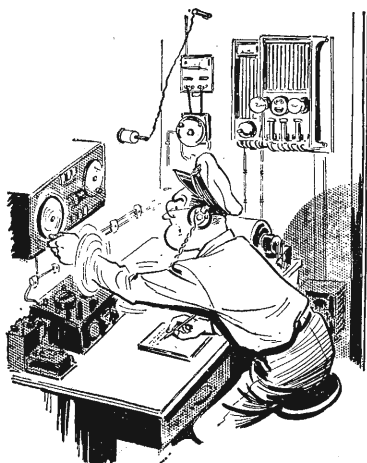

Manhandling "Maggie".

transmitters now operating. I wonder if it would not be a good idea to rebuild the original 25-kW transmitter at Poldhu as a memorial to Marconi, and thus enable his original experiment to be repeated.

I thought the most interesting things in the show were the exhibits relating to a few years after 1901, when ship-to-shore communication had become well established. The magnetic detector of 1902 was particularly interesting, but I don't think it was made sufficiently clear to visitors that although the commercial version shown was perfected by Marconi and his associates, it was not his invention; in fact, a primitive version was used five years

earlier, in 1897, by Rutherford to receive signals sent across Cambridge.

I was very fortunate when gazing at the instrument to hear two very academic types discussing the scientific principle of magnetic hysteresis upon which its working depends. One, who had a schoolboy with him, gave a very learned dissertation upon the subject for the boy's benefit, and mesmerized him and me by a miasma of mathematics. He juggled with sines and cosines with such breath-taking dexterity that the boy seemed to become a little giddy, and when the learned man paused for breath he shot an entirely irrelevant question at him concerning the function of the two little white knobs, one on each of the two grooved wheels which transported the soft-iron band.

It was at once evident to me from his reply that although the savant was an expert on magnetic hysteresis he was completely out of his depth in the matter of the unpredictable womanlike hysteria of the driving spring of the clockwork mechanism, especially in humid tropical conditions. The schoolboy must have seen the pained look on the face of an official standing by, because he turned to him for further guidance.

The knobs were, of course, provided so that the mechanism could be turned by hand if the driving spring broke, the operator turning with his left hand as he wrote with his right. I have always thought that the provision of a knob on each wheel was to make things easy for a left-handed operator who needed his left hand for writing. If I am wrong in my assumption I shall be glad to know the correct answer.

Etymological Evolution

I WONDER if any of you can tell me what the word "transistor" is intended to mean? Now please don't all rush to send me a copy of Scroggie's book on semiconductors. Actually I already have one, and it is at this very moment propping up one leg of the table on which I am writing these few words, and so forming a very good example of applied science.

What I want to get at is how this magic word was arrived at by Bardeen, Brattain and Shockley in the Bell Telephone Laboratories where they minted both the device and, I presume, the name. We all know that the word "radar" is built up of the initial letters of a sentence

describing its functions, but "transistor" is not quite like that.

One is tempted to split up the word into our old friend "trans" and "istor" which is a fragment of the word resistor, such fragmenting being an indication that the device is not a full-blooded resistor but only partly so, or in other words, a semiconductor.

I am told this explanation is quite wrong as far as the first part of the word is concerned although correct in the case of the "istor." I am informed that the initial "tr" of transistor really represents the first two letters of the word "triode" since the evolving of the transistor from the crystal diode in 1948 was virtually on a par with the putting of the grid in Fleming's thermionic diode.

It would seem logical to tidy up our nomenclature and call the photocell a photistor for, after all, it is a device which varies its resistance and therefore its conductivity under the influence of light. But if we did that we should have to use the word thermistor—already booked—to describe a thermionic valve which varies its inter-electrode resistance and other characteristics when we turn the wick up or down, as those of us who used to work with soft-valve detectors know full well.

'Your Tiny Hand is Frozen'

I THINK you will agree that a criticism of pianos has no place in the pages of this journal but in view of the fact that they have gate-crashed into the Radio Show, piano manufacturers cannot hope to escape criticism. In any case I would like to suggest a small but important improvement in their construction involving the use of electrical technique and that can be my excuse for talking about pianos in *W.W.*

I am not a pianist although my father endeavoured to force me to become one at a very early age. But he damned any hope of success he may have cherished by forcing me to practise in a bitterly cold room in the depths of winter. The result was that instead of acquiring the skill of a Paderewski, I developed chilblains on my fingers from contact with the icy ivory of the piano keys.

I have never forgotten this and that is why I would like to suggest with some bitterness that if piano manufacturers want to continue to be allowed into the Radio Show, they should at least arrange to fit their wares with electrically heated keys, for even in a room at a civilized temperature piano keys are uncomfortably chilly things.

It would be such a very simple thing to fit each key with a tiny replaceable heating element; the current consumption would be negligible. The same thing, of course, applies to typewriter keys.